

# SPECIFICATION FOR LCD MODULE

Model No. TM128128CKFWG

<b>Prepared by:</b>	<b>Date:</b>
<b>Checked by :</b>	<b>Date:</b>
<b>Verified by :</b>	<b>Date:</b>
<b>Approved by:</b>	<b>Date:</b>

**TIANMA MICROELECTRONICS CO., LTD**

**REVISION RECORD**

<b>Date</b>	<b>Ver.</b>	<b>Ref. Page</b>	<b>Revision No.</b>	<b>Revision Items</b>

## 1. General Specifications:

- 1.1 Display type: COLOR STN
- 1.2 Display color\*<sup>1</sup>:
  - Display color: 65K COLOR
  - Background\*<sup>2</sup>: Black (Red, Green, Blue dots are off state)
- 1.3 Polarizer mode: Transmissive/Negative
- 1.4 Viewing Angle: 6:00
- 1.5 Driving Method: 1/128 Duty 1/5 Bias
- 1.6 Backlight Type: LED (3 LAMPS)
  - Backlight Color: WHITE
- 1.7 Controller: S6B33B0
- 1.8 Data Transfer: 16 Bit Parallel
- 1.9 Operating Temperature: -20----+70
  - Storage Temperature: -30----+80
- 1.10 Power Supply Voltage: VDD=3.0V
- 1.11 LCD Operating Voltage: VLCD=10.6V
- 1.12 Outline Dimensions: Refer to outline drawing on next page
- 1.13 Dot Matrix: 128 X 3 (RGB) X 128 Dots
- 1.14 Dot Size: 0.192(R+G+B) × 0.210(mm<sup>2</sup>)
- 1.15 Dot Pitch: 0.204 × 0.220 (mm<sup>2</sup>)
- 1.16 Weight: TBD\*<sup>3</sup>

\*<sup>1</sup> Color tone is slightly changed by temperature and driving voltage.

\*<sup>2</sup> Color tone will be changed by backlight.

\*<sup>3</sup> TBD: To Be Determined.

## 2. Outline Drawing

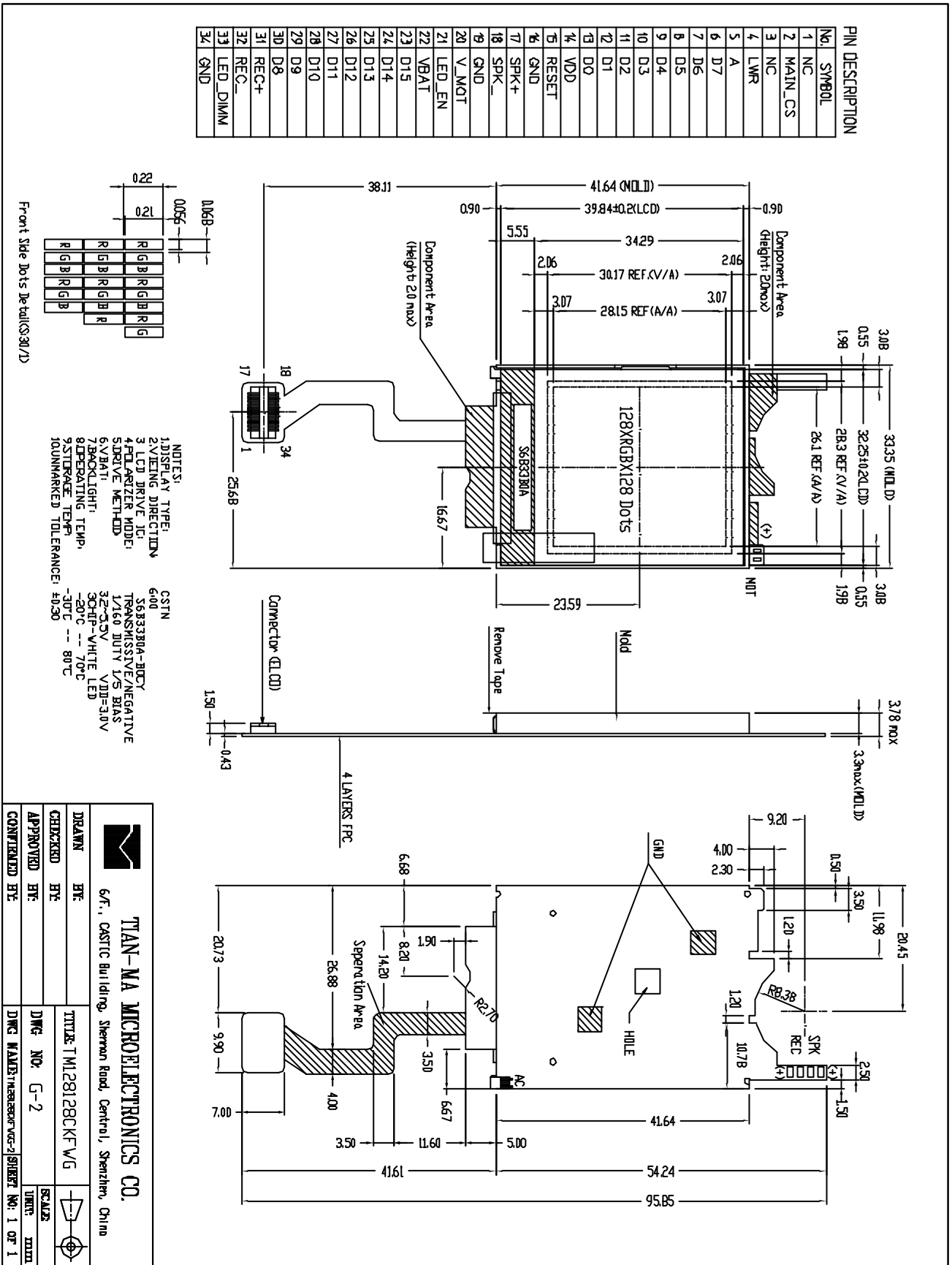

### 3. LCD Module Part Numbering System

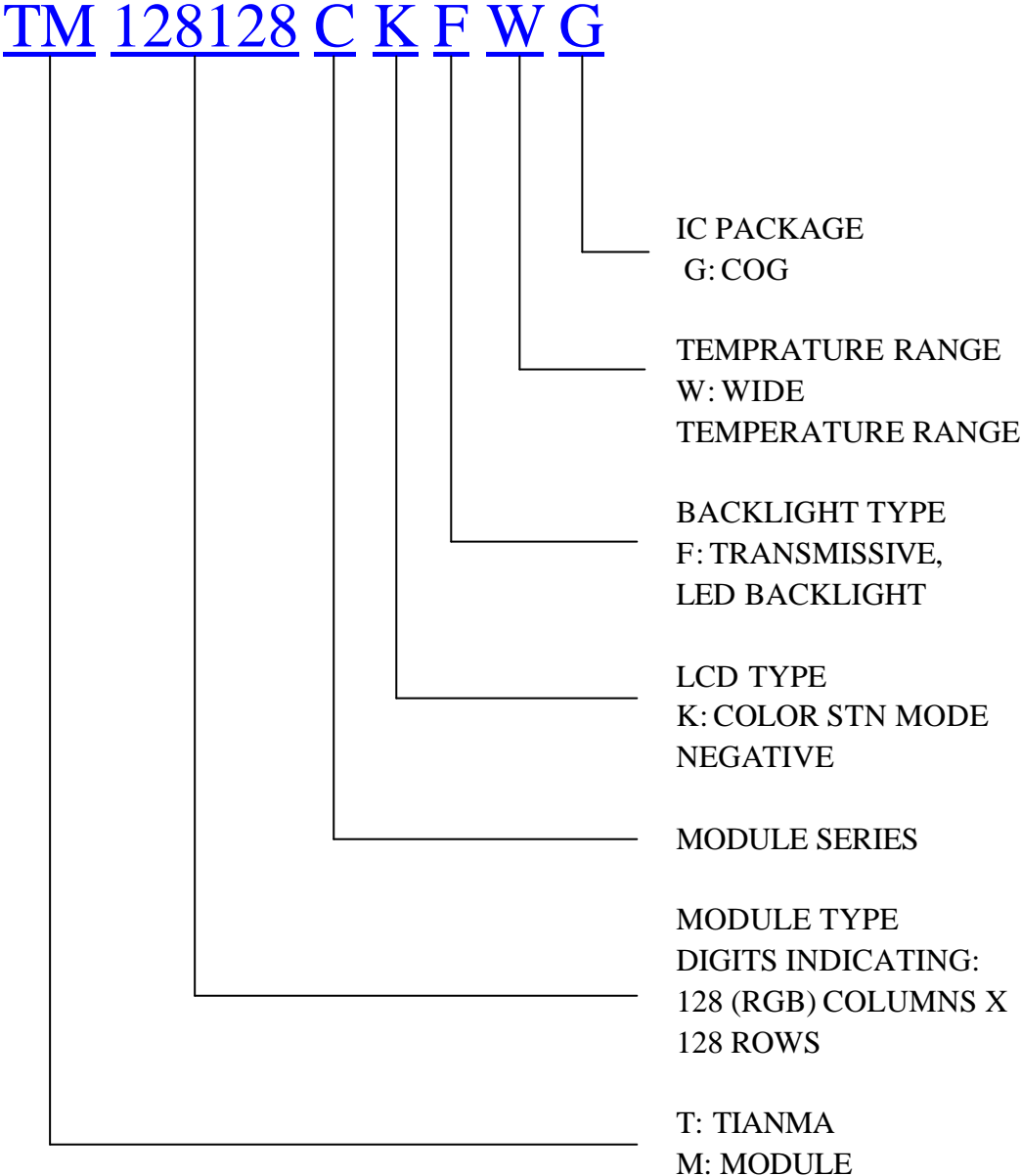

# 4. Circuit Block Diagram

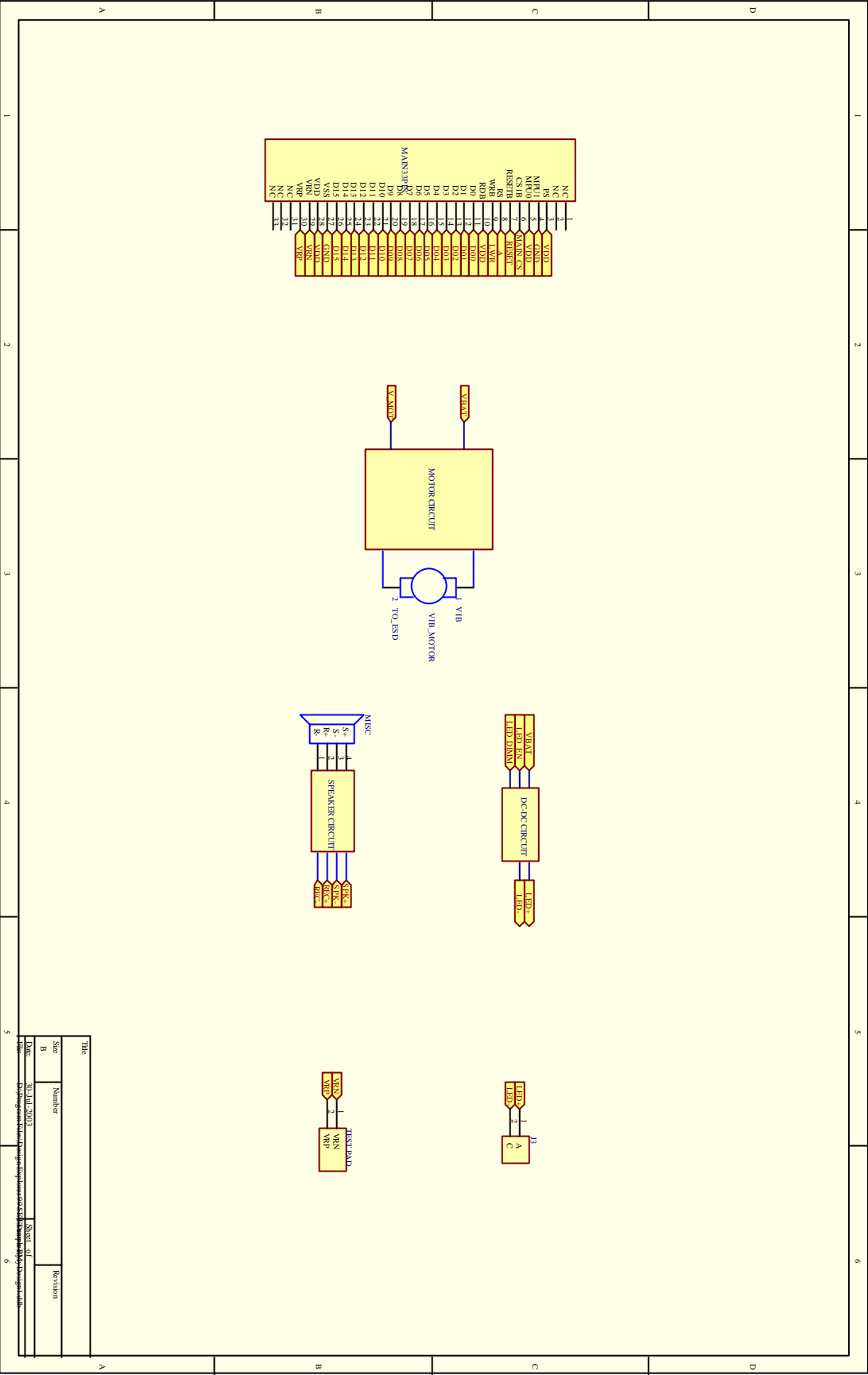

## 5. Absolute Maximum Ratings

Ta=25

Item	Symbol	Min.	Max.	Unit	Remark
Power Supply Voltage	V <sub>DD</sub> - V <sub>SS</sub>	-0.3	+4.0	V	
LCD Driving Voltage	V <sub>LCD</sub>	TBD	22		
Operating Temperature Range	T <sub>OP</sub>	-20	+70		No Condensation
Storage Temperature Range	T <sub>ST</sub>	-30	+80		

## 6. Electrical Specifications and Instruction Code

### 6.1 Electrical characteristics

$V_{SS}=0V$ ,  $T_a=25$

Item	Symbol	Min.	Typ.	Max.	Unit
Supply Voltage (Logic)	$V_{DD}-V_{SS}$	+1.8	+3.0	+3.3	V
Supply Voltage (LCD Drive)	$V_{LCD}$	-	10.6	-	V
Input Signal Voltage	High $V_{IH}$ ( $V_{DD}=3.0$ )	$0.8V_{DD}$	-	$V_{DD}$	V
	Low $V_{IL}$ ( $V_{DD}=3.0$ )	0	-	$0.2 V_{DD}$	V
Supply current (Logic)	$I_{DD}$ ( $V_{DD}-V_{SS}=3.0V$ )	-	-	2.5	mA
Operating current	$I_{op}$	-	-	60	mA
Oscillator frequency range	$f_{osc}$	84.48	-	288	KHz
Supply Voltage (LED)	$V_{LED}$	-	9.9	-	V
Supply current (LED)	$I_{LED}$		15.0	20.0	mA



## 6.2 Interface Signals

### 6.2.1 CN1

Pin No.	Symbol	Level	Description
1	NC		
2	MAIN_CS	H/L	Chip select: Low active
3	NC		
4	LWR	H/L	Signal to select data write operation(80-system)
5	A	H/L	Index register / Data command select
6	D07	H/L	Data bus bit 7
7	D06	H/L	Data bus bit 6
8	D05	H/L	Data bus bit 5
9	D04	H/L	Data bus bit 4
10	D03	H/L	Data bus bit 3
11	D02	H/L	Data bus bit 2
12	D01	H/L	Data bus bit 1
13	D00	H/L	Data bus bit 0
14	VDD	3.0V	Logic circuit power supply
15	RESET	H/L	Reset pin: Low active
16	GND	0V	Ground
17	SPK+	H/L	Speaker input pin(+)
18	SPK_	H/L	Speaker input pin(-)
19	GND	0V	Ground
20	V_MOT	H/L	Motor drive pin(L:active)
21	LED_EN	H/L	LED enable pin
22	Vbat	Vbat	Battery power supply
23	D15	H/L	Data bus bit 15
24	D14	H/L	Data bus bit 14
25	D13	H/L	Data bus bit 13
26	D12	H/L	Data bus bit 12
27	D11	H/L	Data bus bit 11

Pin No.	Symbol	Level	Description
28	D10	H/L	Data bus bit 10
29	D09	H/L	Data bus bit 9
30	D08	H/L	Data bus bit 8
31	REC+	H/L	Receiver input pin(+)
32	REC_	H/L	Receiver input pin(-)
33	LED_DIMM	H/L	LED luminosity control(H:bright)
34	GND	0V	Ground

### 6.2.2 CN2

Pin No.	Symbol	Level	Description
1, 2	CATHODE	0V	LED CATHODE
3, 4	ANODE	9.9V	LED ANODE

### 6.3 Interface Timing Chart

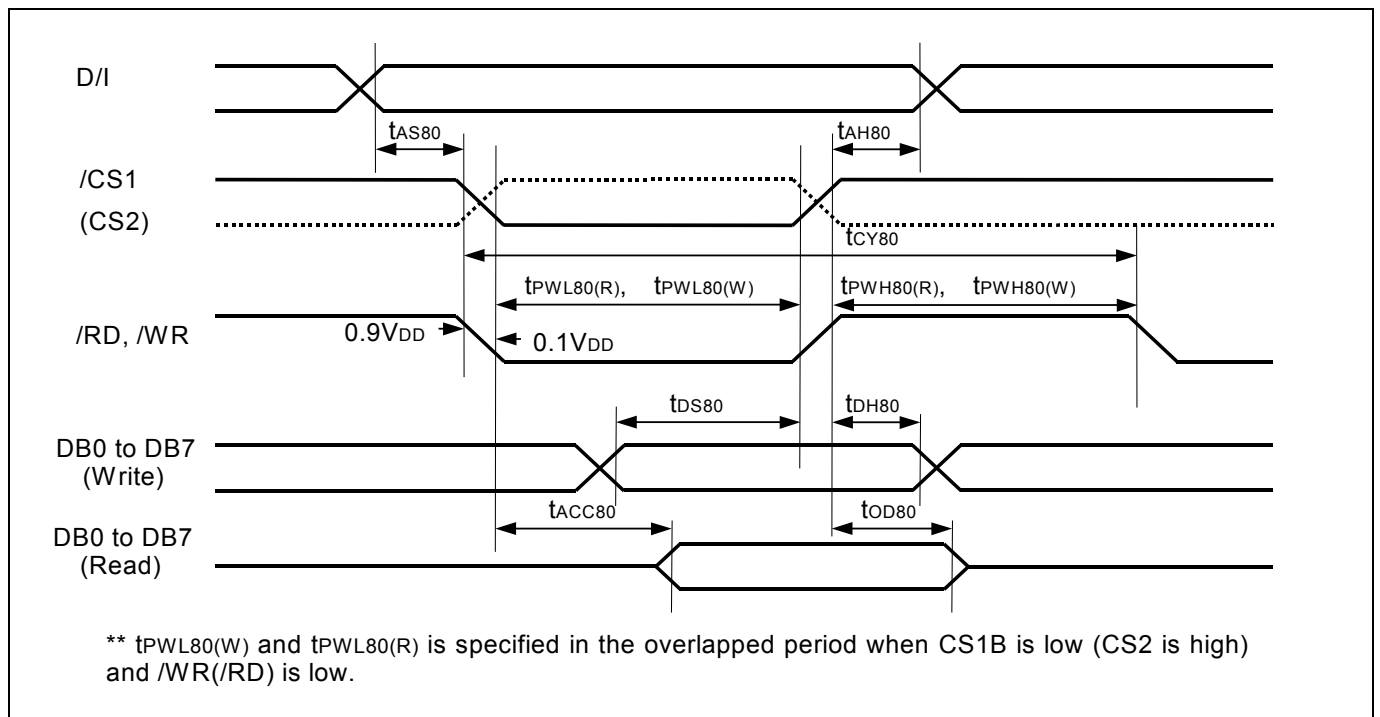

**Parallel Interface (8080-series MPU) Timing Diagram**

## 6.4 Instruction code

Instruction Table

Instruction Name	D/I	WRB	RDB	DB15 ~DB8	DB7	DB6	DB5	DB4	DB3	DB2	DB1	DB0	Hex.	Parameter
Non Operation	0	0	1	*	0	0	0	0	0	0	0	0	00	
Oscillation Mode Set	0	0	1	*	0	0	0	0	0	0	1	0	02	1Byte
Driver Output Mode Set	0	0	1	*	0	0	0	1	0	0	0	0	10	1Byte
DC-DC Select	0	0	1	*	0	0	1	0	0	0	0	0	20	1Byte
Bias Set	0	0	1	*	0	0	1	0	0	0	1	0	22	1Byte
DCDC Clock Division Set	0	0	1	*	0	0	1	0	0	1	0	0	24	1Byte
DCDC and AMP ON/OFF set	0	0	1	*	0	0	1	0	0	1	1	0	26	1Byte
Temperature Compensation Set	0	0	1	*	0	0	1	0	1	0	0	0	28	1Byte
Contrast Control(1)	0	0	1	*	0	0	1	0	1	0	1	0	2A	1Byte
Contrast Control(2)	0	0	1	*	0	0	1	0	1	0	1	1	2B	1Byte
Standby Mode OFF	0	0	1	*	0	0	1	0	1	1	0	0	2C	-
Standby Mode ON	0	0	1	*	0	0	1	0	1	1	0	1	2D	-
DDRAM Burst Mode OFF	0	0	1	*	0	0	1	0	1	1	1	0	2E	-
DDRAM Burst Mode ON	0	0	1	*	0	0	1	0	1	1	1	1	2F	-
Addressing Mode Set	0	0	1	*	0	0	1	1	0	0	0	0	30	1Byte
ROW Vector Mode Set	0	0	1	*	0	0	1	1	0	0	1	0	32	1Byte
N-line Inversion Set	0	0	1	*	0	0	1	1	0	1	0	0	34	1Byte
Entry Mode Set	0	0	1	*	0	1	0	0	0	0	0	0	40	1Byte
X-address Area Set	0	0	1	*	0	1	0	0	0	0	1	0	42	2Byte
Y-address Area Set	0	0	1	*	0	1	0	0	0	0	1	1	43	2Byte
RAM Skip Area Set	0	0	1	*	0	1	0	0	0	1	0	1	45	1Byte
Display OFF	0	0	1	*	0	1	0	1	0	0	0	0	50	-
Display ON	0	0	1	*	0	1	0	1	0	0	0	1	51	-
Specified Display Pattern Set	0	0	1	*	0	1	0	1	0	0	1	1	53	1Byte
Partial Display Mode Set	0	0	1	*	0	1	0	1	0	1	0	1	55	1Byte
Partial Display Start Line Set	0	0	1	*	0	1	0	1	0	1	1	0	56	1Byte
Partial Display End Line Set	0	0	1	*	0	1	0	1	0	1	1	1	57	1Byte
Area Scroll Mode Set	0	0	1	*	0	1	0	1	1	0	0	1	59	4Byte
Scroll Start Line Set	0	0	1	*	0	1	0	1	1	0	1	0	5A	1Byte
Set Display Data Length	X	X	X	*	1	1	1	1	1	1	0	0	FC	1Byte
Display Data Write	1	0	1		Display Data Write							-	-	
Display Data Read	1	1	0		Display Data Read							-	-	
Status Read	0	1	0	0	Status Data Read							-	-	
Test Mode1	0	0	1	*	1	1	1	1	1	1	1	1	FF	-
Test Mode2	0	0	1	*	1	1	1	1	1	1	1	0	FE	-
Test Mode3	0	0	1	*	1	1	1	1	1	1	0	1	FD	-
Test Mode4	0	0	1	*	1	1	1	1	1	0	1	1	FB	-
Test Mode5	0	0	1	*	1	1	1	1	1	0	1	0	FA	-
Test Mode6	0	0	1	*	1	1	1	1	1	0	0	1	F9	-

\*: Don't care

## 7. Optical Characteristics

### 7.1 Optical Characteristics

V<sub>LCD</sub>=10.6V Ta=25

Item	Symbol	Condition	Min.	Typ.	Max.	Unit	
Viewing Angle	x	Cr=2	y=0 °	-40 -- +35		Deg	
	y			-30 -- +30			
Contrast Ratio	Cr	x=0 ° y=0 °	30	-	-		
Response Time	Turn on	T <sub>on</sub>	x=0 ° y=0 °	-	-	200	ms
	Turn off	T <sub>off</sub>		-	-	100	
Color Of CIE Coord-Inate	Red	x	x=0 ° y=0 °	-	0.43	-	cd/m <sup>2</sup>
		y		-	0.35	-	
	Green	x	x=0 ° y=0 °	-	0.32	-	cd/m <sup>2</sup>
		y		-	0.46	-	
	Blue	x	x=0 ° y=0 °	-	0.22	-	cd/m <sup>2</sup>
		y		-	0.26	-	

## 7.2 Definition of Optical Characteristics

### 7.2.1 Definition of Viewing Angle

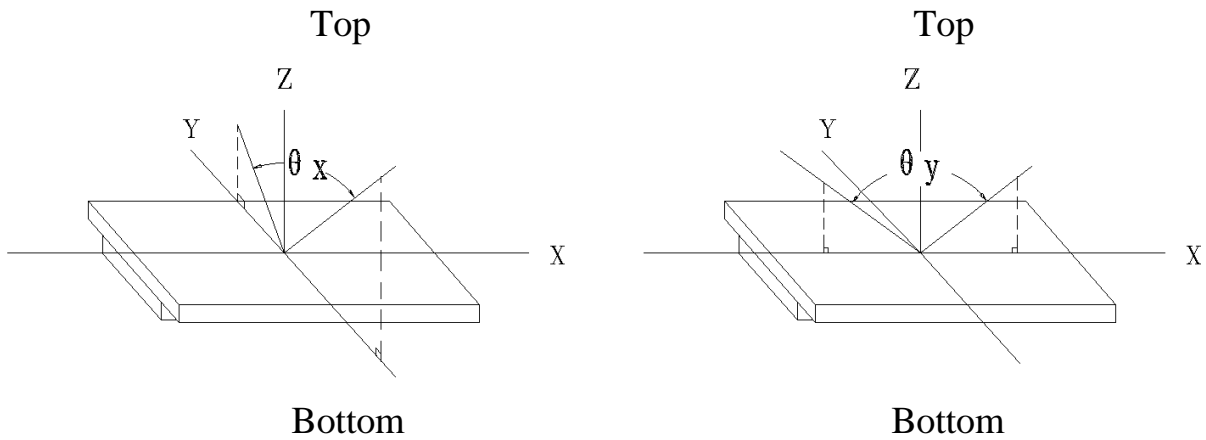

### 7.2.2 Definition of Contrast Ratio

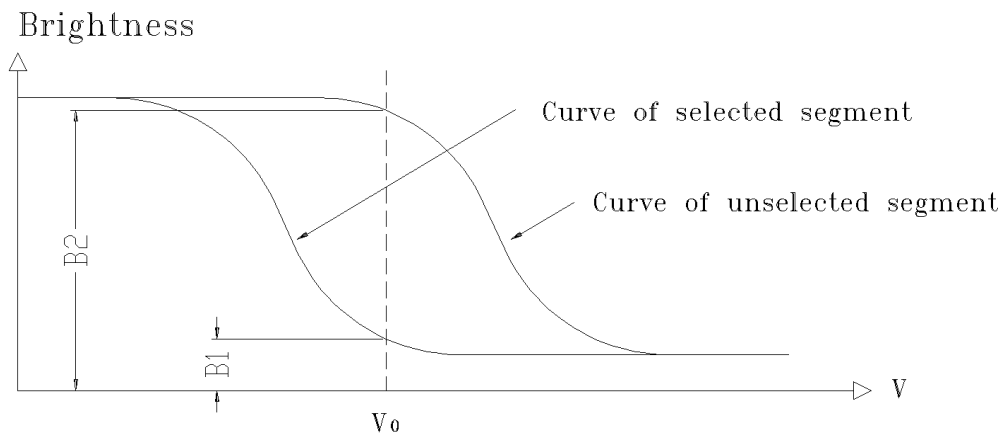

$$\text{Contrast Ratio} = B2/B1 = \frac{\text{unselected state brightness}}{\text{selected state brightness}}$$

Measuring Conditions:

- 1) Ambient Temperature: 25 ;
- 2) Frame frequency: 70.0Hz

### 7.2.3 Definition of Response time

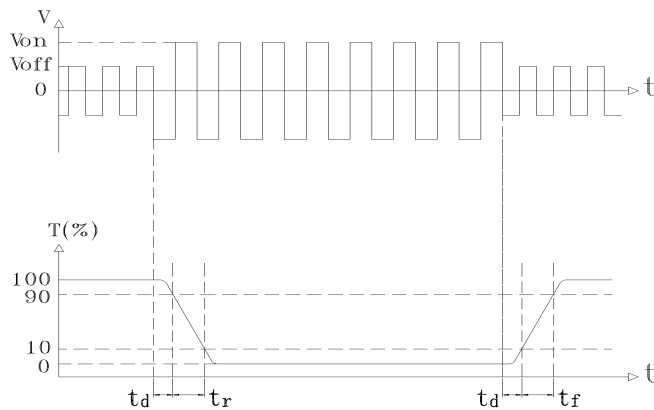

Turn on time:  $t_{on} = t_d + t_r$       Turn off time:  $t_{off} = t_d + t_f$

Measuring Condition:

- 1) Operating Voltage: 10.6V
- 2) Frame frequency: 70.0Hz

### 7.3 Brightness Characteristic

Item	Symbol	Condition	Min.	Typ.	Max.	Unit
Brightness	Bp	Ta=25 ±3	65	-	-	cd/m <sup>2</sup>
Uniformity	Bp	30-80%RH	-	-	60	%

Note:

1. The data is measured after LEDs are turned on for 5 minutes.
2. Testing conditions   LED: V<sub>LED</sub> = 9.9 V (DC)  
                                  LCD: All dots are on (White color)
3. Brightness in the center of the LCD panel.
4. Definition of Uniformity ( Bp)  
       $Bp = Bp \text{ (Min.)} / Bp \text{ (Max.)} \times 100 \text{ (\%)}$   
      Bp (Max.) = Maximum brightness in 9 measurement spots  
      Bp (Min.) = Minimum brightness in 9 measurement spots

## 8. Reliability

### 8.1 Content of Reliability Test

Ta=25

No.	Test Item	Content of Test	Test condition
1	High Temperature Storage	Endurance test applying the high storage temperature for a long time	80 ±2 240H Restore 4H at 25
2	Low Temperature Storage	Endurance test applying the low storage temperature for a long time	-30 ±2 240H Restore 4H at 25
3	High Temperature /Humidity Storage	Endurance test applying the high temperature and high humidity storage for a long time	70 ±2 90%RH 240H Restore 4H at 25
4	Temperature Cycle	Endurance test applying the low and high temperature cycle -30 25 80 25 30min 5min 30min 5min 1 cycle	-30 /80 10 cycles Restore 4H at 25
5	Vibration Test (package state)	Endurance test applying the vibration during transportation	10Hz~150Hz, 100m/s <sup>2</sup> , 120min
6	Shock Test (package state)	Endurance test applying the shock during transportation	Half- sine wave, 300m/s <sup>2</sup> , 18ms
7	Atmospheric Pressure Test	Endurance test applying the atmospheric pressure during transportation by air	25kPa 16H Restore 2H

## 8.2 Failure Judgment Criterion

Criterion Item	Test Item No.									Failure Judgement Criterion	
	1	2	3	4	5	6	7	8	9		
Basic Specification	v	v	v	v	v	v	v	v	v	v	Out of the basic Specification
Electrical specification	v	v	v	v	v						Out of the electrical specification
Mechanical Specification							v	v			Out of the mechanical specification
Optical Characteristic	v	v	v	v	v	v				v	Out of the optical specification
Note	For test item refer to 8.1										
Remark	Basic specification = Optical specification + Mechanical specification										



## 9. Quality Level

Examination or Test	At $T_a=25$ (unless otherwise stated)	Inspection				
		Min.	Max.	Unit	IL	AQL
External Visual Inspection	Under normal illumination and eyesight condition, the distance between eyes and LCD is 25cm.	See Appendix A			II	Major 1.0 Minor 2.5
Display Defects	Under normal illumination and eyesight condition, display on inspection.	See Appendix B			II	Major 1.0 Minor 2.5
<p>Note: Major defects: Open segment or common, Short, Serious damages, Leakage            Miner defects: Others            Sampling standard conforms to GB2828</p>						

## **10. Precautions for Use of LCD Modules**

### 10.1 Handling Precautions

- 10.1.1 The display panel is made of glass. Do not subject it to a mechanical shock by dropping it from a high place, etc.
- 10.1.2 If the display panel is damaged and the liquid crystal substance inside it leaks out, be sure not to get any in your mouth, if the substance comes into contact with your skin or clothes, promptly wash it off using soap and water.
- 10.1.3 Do not apply excessive force to the display surface or the adjoining areas since this may cause the color tone to vary.
- 10.1.4 The polarizer covering the display surface of the LCD module is soft and easily scratched. Handle this polarizer carefully.
- 10.1.5 If the display surface is contaminated, breathe on the surface and gently wipe it with a soft dry cloth. If still not completely clear, moisten cloth with one of the following solvents:
- Isopropyl alcohol
  - Ethyl alcohol
- Solvents other than those mentioned above may damage the polarizer. Especially, do not use the following:
- Water
  - Ketone
  - Aromatic solvents
- 10.1.6 Do not attempt to disassemble the LCD Module.
- 10.1.7 If the logic circuit power is off, do not apply the input signals.
- 10.1.8 To prevent destruction of the elements by static electricity, be careful to maintain an optimum work environment.
- a. Be sure to ground the body when handling the LCD Modules.
  - b. Tools required for assembly, such as soldering irons, must be properly ground.
  - c. To reduce the amount of static electricity generated, do not conduct assembly and other work under dry conditions.
  - d. The LCD Module is coated with a film to protect the display surface. Be care when peeling off this protective film since static electricity may be generated.

## 10.2 Storage precautions

10.2.1 When storing the LCD modules, avoid exposure to direct sunlight or to the light of fluorescent lamps.

10.2.2 The LCD modules should be stored under the storage temperature range. If the LCD modules will be stored for a long time, the recommend condition is:

Temperature :           0    ~  40

Relatively humidity:    80%

10.2.3 The LCD modules should be stored in the room without acid, alkali and harmful gas.

10.3 The LCD modules should be no falling and violent shocking during transportation, and also should avoid excessive press, water, damp and sunshine.

## Appendix A

### Inspection items and criteria for appearance defects

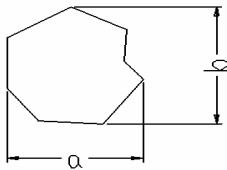
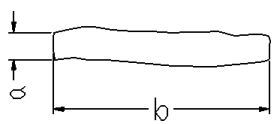
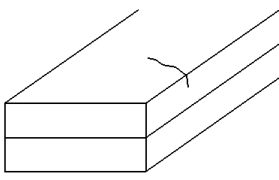
Items	Contents	Criteria		
Leakage		Not permitted		
Rainbow		According to the limit specimen		
Polarizer	Wrong polarizer attachment	Not permitted		
	Bubble between polarizer and glass	Not counted	Max. 3 defects allowed	
		$\phi < 0.3\text{mm}$	0.3mm $\phi$ 0.5mm	
	Scratches of polarizer	According to the limit specimen		
Black spot (in viewing area)		Not counted	Max. 3 spots allowed	Max. 3 spots (lines) allowed
		$X < 0.2\text{mm}$	0.2mm X 0.5mm	
		$X = (a+b)/2$		
Black line (in viewing area)		Not counted	Max. 3 lines allowed	
		$a < 0.02\text{mm}$	0.02mm a 0.05mm b 2.0mm	
Progressive cracks		Not permitted		

## Appendix A

### Inspection item and criteria for appearance defects (continued)

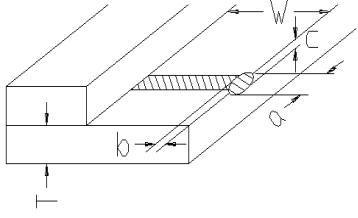
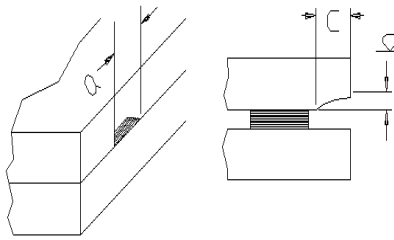
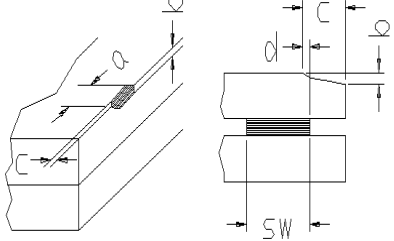
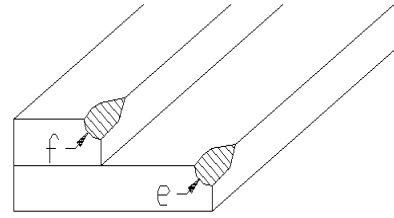
Items	Contents	Criteria							
Glass Cracks	<b>Cracks on pads</b> 	a	b	c	Max. 2 cracks allowed	Max. 5 cracks allowed			
		3mm	W/5	T/2					
		2mm	W/5	$T/2 < C < T$					
	<b>Cracks on contact side</b> 	a	b		Max. 2 cracks allowed				
		3mm	T/2						
		2mm	$T/2 < b < T$						
		C shall be not reach the seal area							
	<b>Cracks on non-contact side</b> 	a	b						
		3mm	T/2						
		2mm	$T/2 < b < T$						
	C 0.5mm								
	d SW/3								
<b>Corner cracks</b> 	$e < 2.0\text{mm}^2$ $f < 2.0\text{mm}^2$			Max. 3 cracks allowed					

## Appendix B

### Inspection items and criteria for display defects

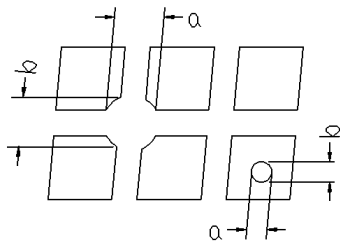
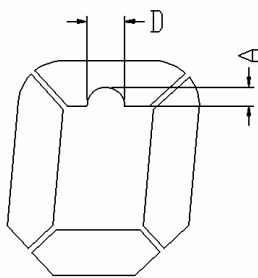
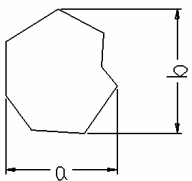
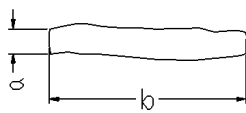
Items	Contents	Criteria		
Open segment or open common		Not permitted		
Short		Not permitted		
Wrong viewing angle		Not permitted		
Contrast ratio uneven		According to the limit specimen		
Crosstalk		According to the limit specimen		
Pin holes and cracks in segment (DOT)		Not counted	Max.3 dots allowed	Max.3 dots allowed
		$X < 0.1\text{mm}$	0.1mm X 0.2mm	
		$X = (a+b)/2$		
		Not counted	Max.2 dots allowed	
$A < 0.1\text{mm}$		0.1mm A 0.2mm $D < 0.25\text{mm}$		
Black spot (in viewing area)		Not counted	Max.3 spots allowed	Max.3 spots (lines) allowed
		$X < 0.1\text{mm}$	0.1mm X 0.2mm	
		$X = (a+b)/2$		
Black line (in viewing area)		Not counted	Max.3 lines allowed	
		$a < 0.02\text{mm}$	0.02mm a 0.05mm b 0.5mm	

## Appendix B

### Inspection items and criteria for display defects (continued)

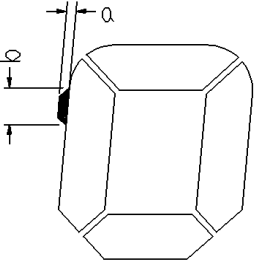
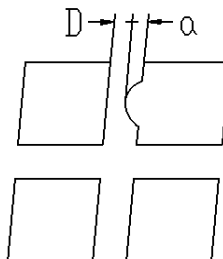
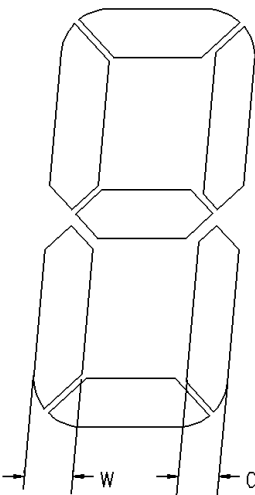
Items	Content	Criteria		
Transformation of segment		Not counted	Max. 2 defects allowed	Max.3 defects allowed
		$x < 0.1\text{mm}$	0.1mm x 0.2mm	
		$x = (a+b)/2$		
		Not counted	Max. 1 defects allowed	
		$a < 0.1\text{mm}$	0.1mm a 0.2mm $D > 0$	
		Max.2 defects allowed $0.8W \leq a \leq 1.2W$  $a = \text{measured value of width}$ $W = \text{nominal value of width}$		