

SPECIFICATION FOR LCD MODULE

Model No. TM128160EKFWG

Prepared by:	Date:
Checked by :	Date:
Verified by :	Date:
Approved by:	Date:

TIANMA MICROELECTRONICS CO., LTD

REVISION RECORD

Date	Ver.	Ref. Page	Revision No.	Revision Item

1. General Specifications:

- 1.1 Display type: COLOR STN
- 1.2 Display color*¹:
 - Display color: 65K COLOR
 - Background*²: Black (Red, Green, Blue dots are off state)
- 1.3 Polarizer mode: Transmissive/Negative
- 1.4 Viewing Angle: 6:00
- 1.5 Driving Method: 1/160 Duty 1/5 Bias
- 1.6 Backlight Type: LED (3 LAMPS)
 - Backlight Color: WHITE
- 1.7 Controller: S6B33B0A-B0CY
- 1.8 Data Transfer: 8 Bit Parallel
- 1.9 Operating Temperature: -20----+70
 - Storage Temperature: -30----+80
- 1.10 VBAT Supply Voltage: VBAT=3.2~4.5V
- 1.11 LCD Operating Voltage: VLCD=16.8V
- 1.12 Outline Dimensions: Refer to outline drawing on next page
- 1.13 Dot Matrix: 128 X 3 (RGB) X 160 Dots
- 1.14 Dot Size: 0.227(R+G+B) × 0.215(mm²)
- 1.15 Dot Pitch: 0.237 × 0.225 (mm²)
- 1.16 Weight: TBD*³

*¹ Color tone is slightly changed by temperature and driving voltage.

*² Color tone will be changed by backlight.

*³ TBD: To Be Determined.

2. Outline Drawing

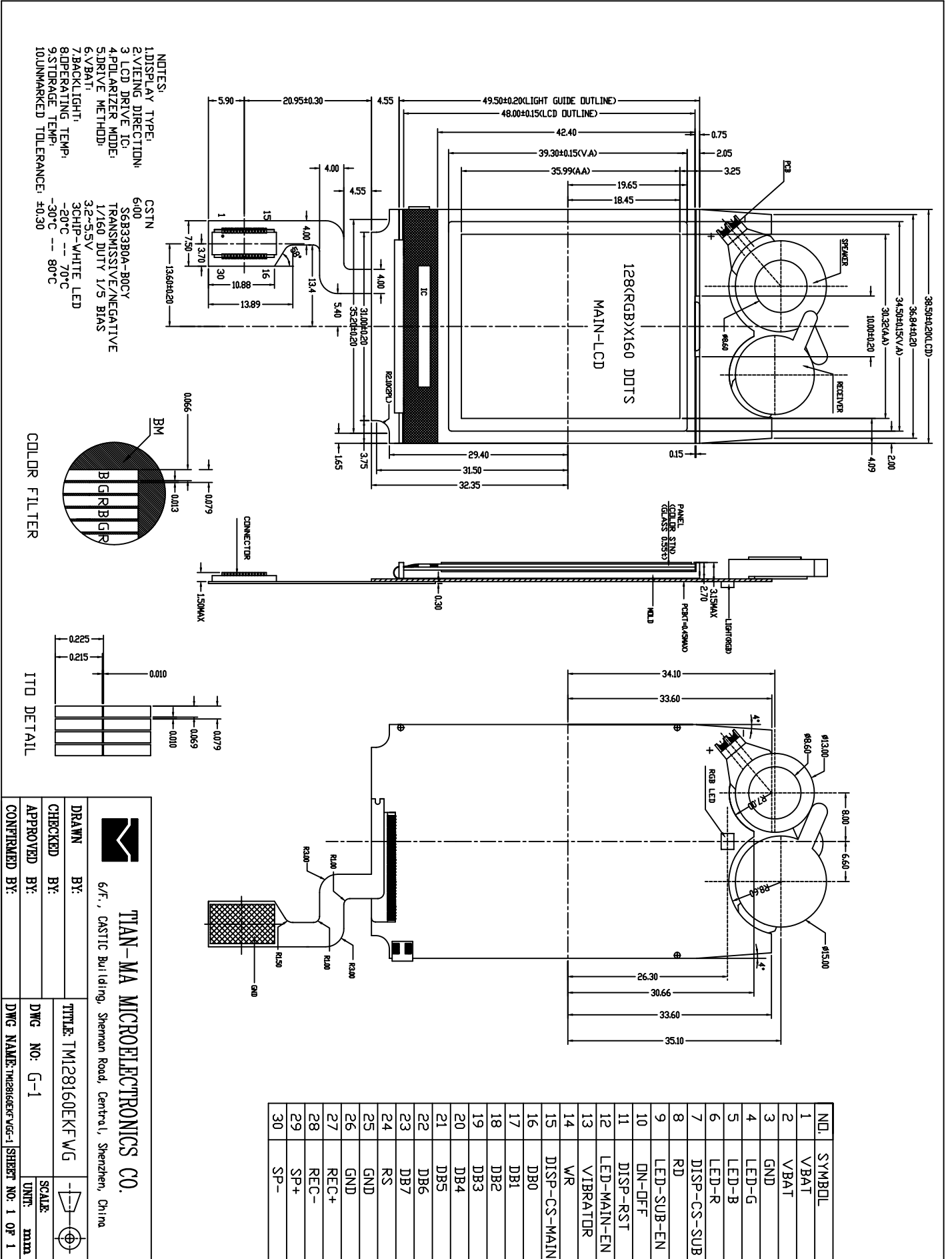

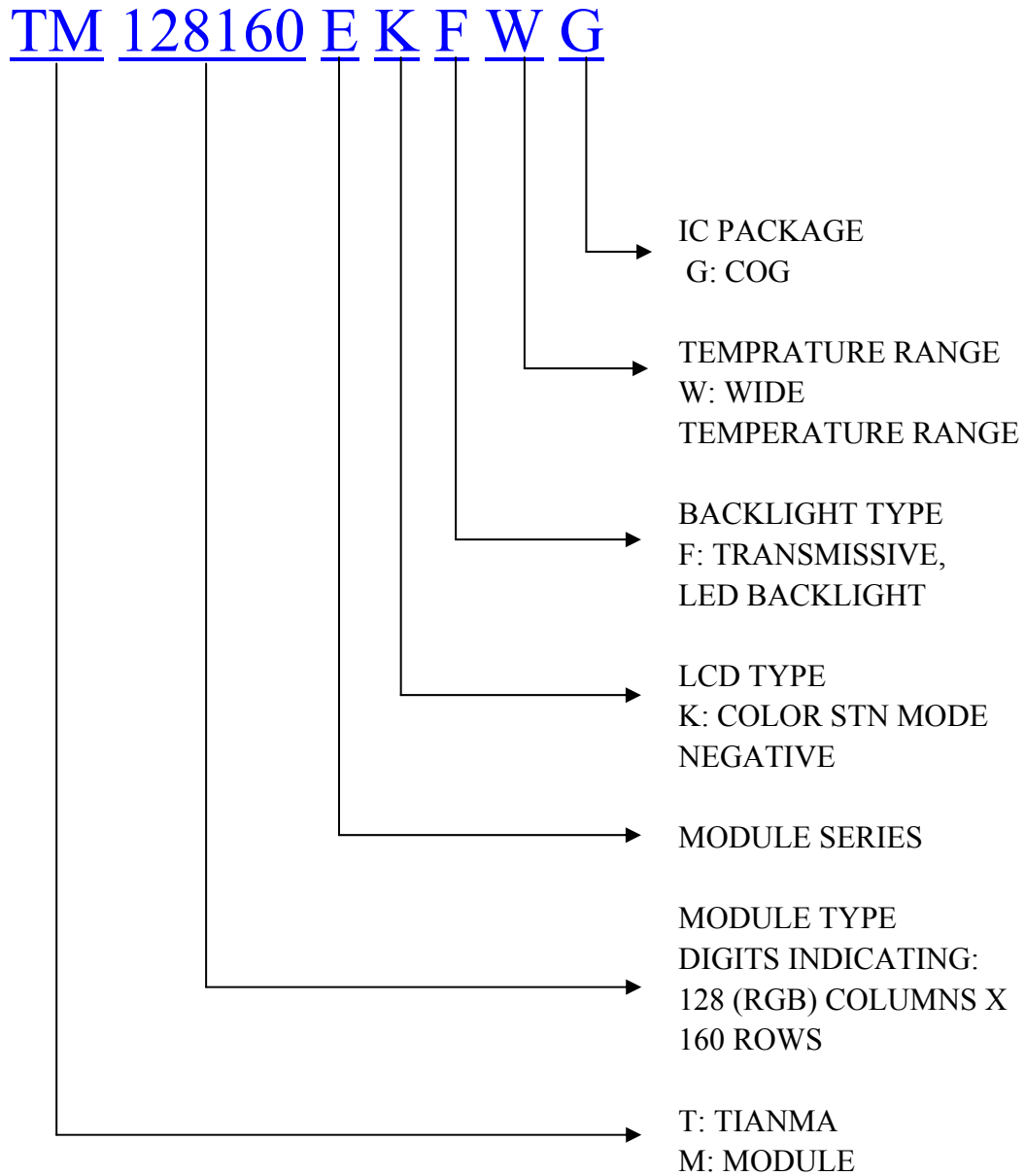

3. LCD Module Part Numbering System

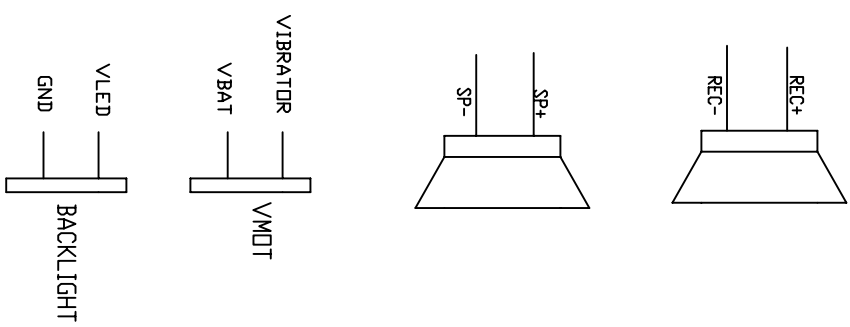
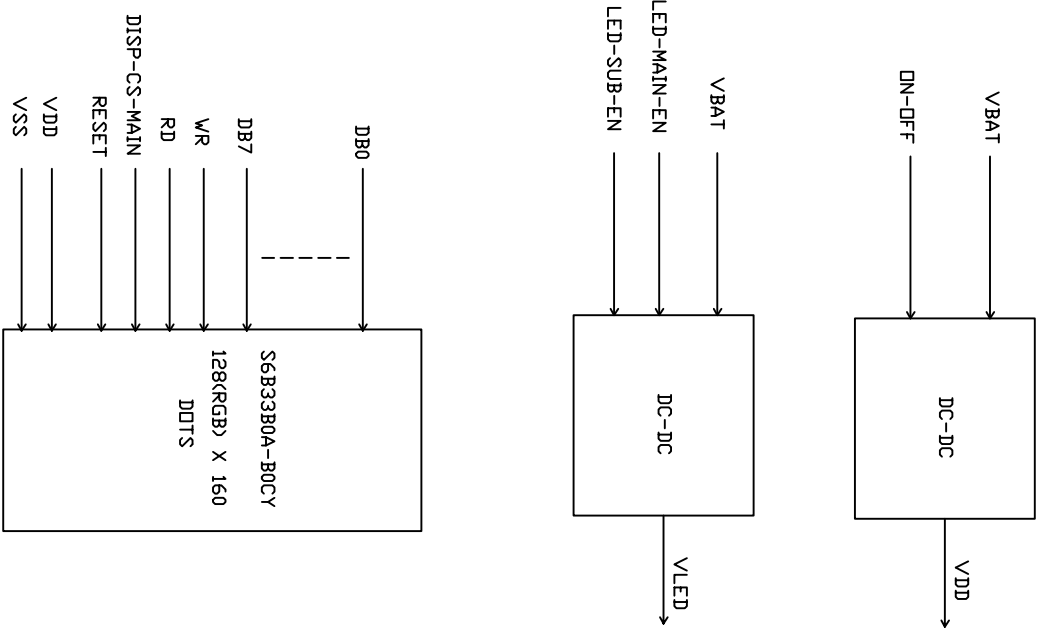

4. Circuit Block Diagram

NO.	SYMBOL
1	VBAT
2	VBAT
3	GND
4	LED-G
5	LED-B
6	LED-R
7	DISP-CS-SUB
8	RD
9	LED-SUB-EN
10	DN-OFF
11	DISP-RST
12	LED-MAIN-EN
13	VIBRATOR
14	WR
15	DISP-CS-MAIN
16	DB0
17	DB1
18	DB2
19	DB3
20	DB4
21	DB5
22	DB6
23	DB7
24	RS
25	GND
26	GND
27	REC+
28	REC-
29	SP+
30	SP-



 TIAN-MA MICROELECTRONICS CO. 22/F., HANGOU Building, Shennan Road, Central, Shenzhen, China	
DRAWN BY:	TITLE: TM128160EG
CHECKED BY:	DWG NO: C-1
APPROVED BY:	DWG NAME: TM128160EG C-1
	SHEET NO: 1 OF 1

5. Absolute Maximum Ratings

Ta=25

Item	Symbol	Min.	Max.	Unit	Remark
Power Supply Voltage	$V_{DD} - V_{SS}$	-0.3	+4.6	V	
LCD Driving Voltage	V_{LCD}	-0.3	+20.0		
Operating Temperature Range	T_{OP}	-20	+70		No Condensation
Storage Temperature Range	T_{ST}	-30	+80		

6. Electrical Specifications and Instruction Code

6.1 Electrical characteristics

$V_{DD}=3V$, $V_{SS}=0V$, $T_a=25$

Item	Symbol	Min.	Typ.	Max.	Unit
Supply Voltage (Logic)	$V_{BAT-VSS}$	+3.1	+3.8	+4.5	V
Supply Voltage (LCD Drive)	V_{LCD}	-	16.8	-	V
Input Signal Voltage	High V_{IH} ($V_{DD}=3.0$)	$0.8V_{DD}$	-	V_{DD}	V
	Low V_{IL} ($V_{DD}=3.0$)	0	-	$0.2 V_{DD}$	V
Supply current (Logic)	I_{DD} ($V_{DD}-V_{SS}=3.0V$)	-	-	2.5	mA
Operating current	I_{op}	-	-	60	mA
Oscillator frequency range	f_{osc}	220	-	330	KHz
Supply Voltage (LED)	V_{LED}	-	9.9	-	V
Supply current (LED)	I_{LED}		15.0	20.0	mA

6.2 Interface Signals

PinNo.	Symbol	Level	Description
1	VBAT	H	Power supply
2	VBAT	H	Power supply
3	GND	L	GROUND
4	LED-G	H/L	Green led control pin
5	LED-B	H/L	Blue led control pin
6	LED-R	H/L	Red led control pin
7	DISP-CS-SUB	H/L	NC
8	RD	H/L	Read operation(8080 system)
9	LED-SUB-EN	H/L	Led brightness select pin (half current work)
10	ON-OFF	H/L	VDD on or off. H: active
11	DISP-RST	H/L	Reset pin L: active
12	LED-MAIN-EN	H/L	Led brightness select pin (full current work)
13	VIBRATOR	H/L	VIBRATOR control pin.
14	WR	H/L	Write operation(8080 system)
15	DISP-CS-MAIN	H/L	LCD Chip select pin
16	DB0	H/L	Data bus bit 0
17	DB1	H/L	Data bus bit 1
18	DB2	H/L	Data bus bit 2
19	DB3	H/L	Data bus bit 3
20	DB4	H/L	Data bus bit 4
21	DB5	H/L	Data bus bit 5
22	DB6	H/L	Data bus bit 6
23	DB7	H/L	Data bus bit 7
24	RS	H/L	Index select/Data command select
25	GND	L	GROUND
26	GND	L	GROUND
27	REC+	H/L	Receive input pin(+)
28	REC-	H/L	Receive input pin(-)
29	SP+	H/L	Speak input pin(+)
30	SP-	H/L	Speak input pin(-)

6.3 Interface Timing Chart

Read / Write Characteristics (8080-series MPU)

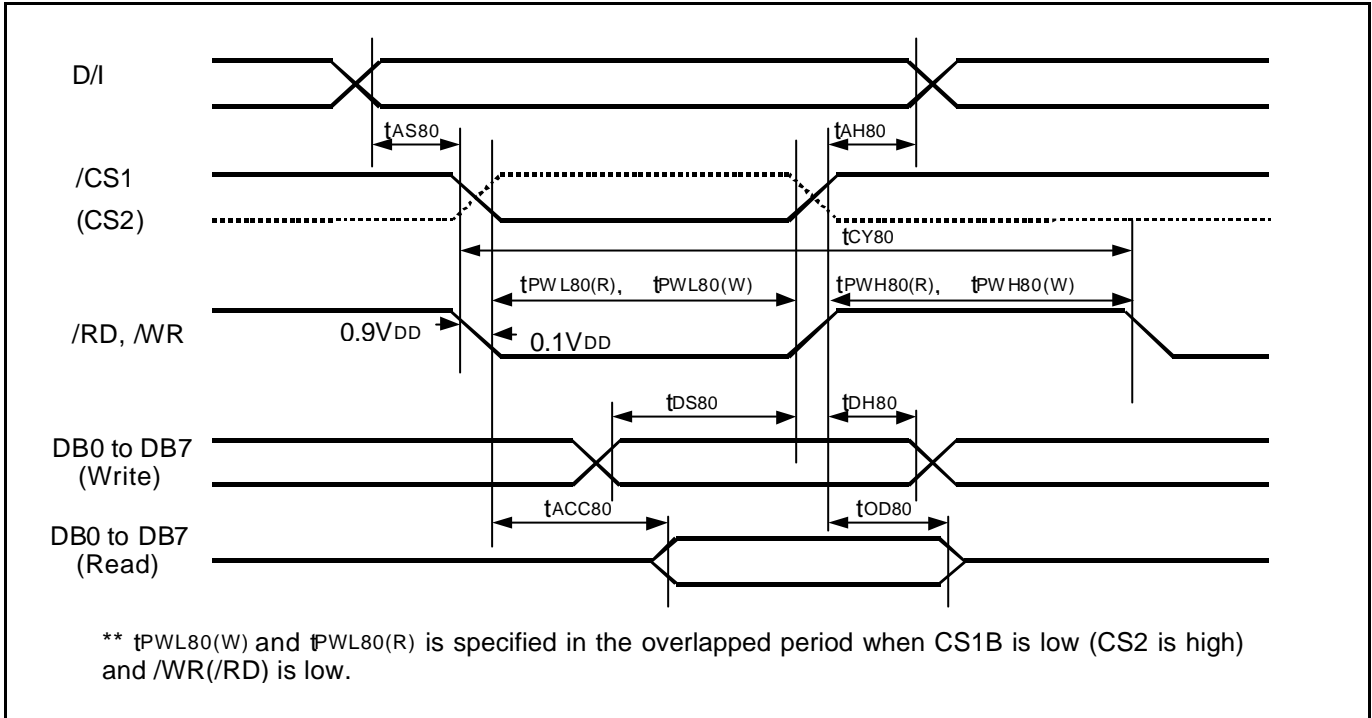

Parallel Interface (8080-series MPU) Timing Diagram

AC Characteristics (8080-series Parallel Mode)

($V_{DD3} = 1.8$ to $3.3V$, $T_a = -30$ to $+70^\circ C$)

Item	Signal	Symbol	Condition	Min.	Max.	Unit
Address setup time	D/I	t_{AS80}			-	ns
Address hold time		t_{AH80}				
System cycle time		t_{CY80}			-	ns
Pulse width low for write	WRB (WRB)	t_{PWLW}			-	ns
Pulse width High for write		t_{PWHW}				
Pulse width low for read	RDB (RDB)	$t_{PWL R}$			-	ns
Pulse width high for read		$t_{PWH R}$				
Data setup time	DB0 to DB15	t_{DS80}			-	ns
Data hold time		t_{DH80}				
Read access time	DB0 to DB15	t_{ACC80}	CL = 100 pF			ns
Output disable time		t_{OD80}				

NOTE: *1. The input signal rise time and fall time (t_r , t_f) is specified at 10 ns or less.
 $(t_r + t_f) < (t_{CY80} - t_{PWLW} - t_{PWHW})$ for write, $(t_r + t_f) < (t_{CY80} - t_{PWL R} - t_{PWH R})$ for read

6.4 Instruction code

Instruction Table

Instruction Name	D/I	WRB	RDB	DB15 ~DB8	DB7	DB6	DB5	DB4	DB3	DB2	DB1	DB0	Hex.	Parameter
Non Operation	0	0	1	*	0	0	0	0	0	0	0	0	00	
Oscillation Mode Set	0	0	1	*	0	0	0	0	0	0	1	0	02	1Byte
Driver Output Mode Set	0	0	1	*	0	0	0	1	0	0	0	0	10	1Byte
DC-DC Select	0	0	1	*	0	0	1	0	0	0	0	0	20	1Byte
Driving current & Bias Set	0	0	1	*	0	0	1	0	0	0	1	0	22	1Byte
DCDC Clock Division Set	0	0	1	*	0	0	1	0	0	1	0	0	24	1Byte
DCDC and AMP ON/OFF set	0	0	1	*	0	0	1	0	0	1	1	0	26	1Byte
Temperature Compensation Set	0	0	1	*	0	0	1	0	1	0	0	0	28	1Byte
Contrast Control(1)	0	0	1	*	0	0	1	0	1	0	1	0	2A	1Byte
Contrast Control(2)	0	0	1	*	0	0	1	0	1	0	1	1	2B	1Byte
Standby Mode OFF	0	0	1	*	0	0	1	0	1	1	0	0	2C	-
Standby Mode ON	0	0	1	*	0	0	1	0	1	1	0	1	2D	-
DDRAM Burst Mode OFF	0	0	1	*	0	0	1	0	1	1	1	0	2E	-
DDRAM Burst Mode ON	0	0	1	*	0	0	1	0	1	1	1	1	2F	-
Addressing Mode Set	0	0	1	*	0	0	1	1	0	0	0	0	30	1Byte
ROW Vector Mode Set	0	0	1	*	0	0	1	1	0	0	1	0	32	1Byte
N-line Inversion Set	0	0	1	*	0	0	1	1	0	1	0	0	34	1Byte
Entry Mode Set	0	0	1	*	0	1	0	0	0	0	0	0	40	1Byte
X-address Area Set	0	0	1	*	0	1	0	0	0	0	1	0	42	2Byte
Y-address Area Set	0	0	1	*	0	1	0	0	0	0	1	1	43	2Byte
RAM Skip Area Set	0	0	1	*	0	1	0	0	0	1	0	1	45	1Byte
Display OFF	0	0	1	*	0	1	0	1	0	0	0	0	50	-
Display ON	0	0	1	*	0	1	0	1	0	0	0	1	51	-
Specified Display Pattern Set	0	0	1	*	0	1	0	1	0	0	1	1	53	1Byte
Partial Display Mode Set	0	0	1	*	0	1	0	1	0	1	0	1	55	1Byte
Partial Display Start Line Set	0	0	1	*	0	1	0	1	0	1	1	0	56	1Byte
Partial Display End Line Set	0	0	1	*	0	1	0	1	0	1	1	1	57	1Byte
Area Scroll Mode Set	0	0	1	*	0	1	0	1	1	0	0	1	59	4Byte
Scroll Start Line Set	0	0	1	*	0	1	0	1	1	0	1	0	5A	1Byte
Set Display Data Length	X	X	X	*	1	1	1	1	1	1	0	0	FC	1Byte
Display Data Write	1	0	1		Display Data Write							-	-	
Display Data Read	1	1	0		Display Data Read							-	-	
Status Read	0	1	0	0	Status Data Read							-	-	
Test Mode1	0	0	1	*	1	1	1	1	1	1	1	1	FF	-
Test Mode2	0	0	1	*	1	1	1	1	1	1	1	0	FE	-
Test Mode3	0	0	1	*	1	1	1	1	1	1	0	1	FD	-
Test Mode4	0	0	1	*	1	1	1	1	1	0	1	1	FB	-
Test Mode5	0	0	1	*	1	1	1	1	1	0	1	0	FA	-
Test Mode6	0	0	1	*	1	1	1	1	1	0	0	1	F9	-

*: Don' t care

Parameter: The number of parameter bytes that follows instruction data.

7. Optical Characteristics

7.1 Optical Characteristics

$V_{LCD}=16.8V$ $T_a=25$

Item		Symbol	Condition	Min.	Typ.	Max.	Unit
Viewing Angle		x	$C_r \geq 2$	$y=0^\circ$	-40 -- +35		Deg
		y		$x=0^\circ$	-30 -- +30		
Contrast Ratio		C_r	$x=0^\circ$ $y=0^\circ$	30	-	-	
Response Time	Turn on	T_{on}	$x=0^\circ$ $y=0^\circ$	-	-	200	ms
	Turn off	T_{off}		-	-	100	
Color Of CIE Coord-Inate	Red	x	$x=0^\circ$ $y=0^\circ$	-	0.43	-	
		y		-	0.35	-	
	Green	x	$x=0^\circ$ $y=0^\circ$	-	0.32	-	
		y		-	0.46	-	
	Blue	x	$x=0^\circ$ $y=0^\circ$	-	0.22	-	
		y		-	0.26	-	

7.2 Definition of Optical Characteristics

7.2.1 Definition of Viewing Angle

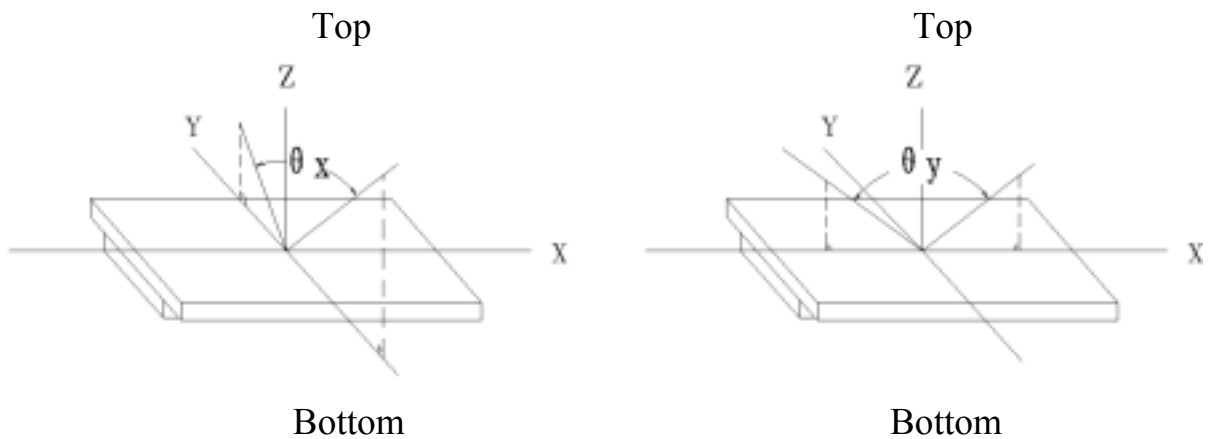

7.2.2 Definition of Contrast Ratio

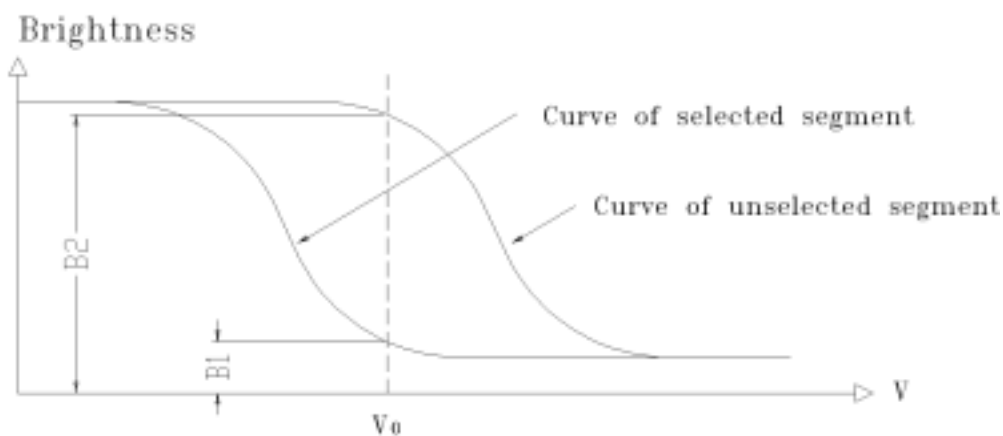

$$\text{Contrast Ratio} = B2/B1 = \frac{\text{unselected state brightness}}{\text{selected state brightness}}$$

Measuring Conditions:

- 1) Ambient Temperature: 25 ;
- 2) Frame frequency: 70.0Hz

7.2.3 Definition of Response time

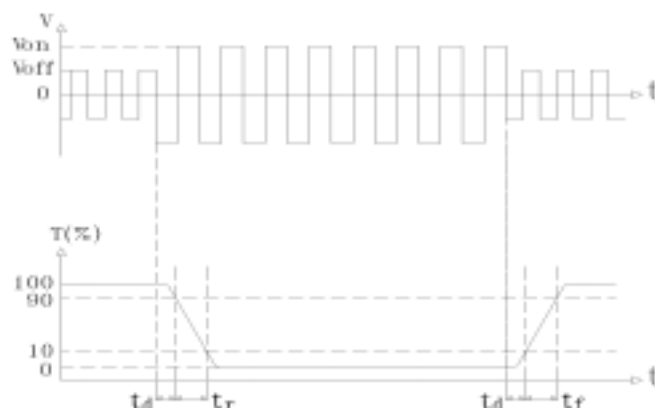

Turn on time: $t_{on} = t_d + t_r$ Turn off time: $t_{off} = t_d + t_f$

Measuring Condition:

- 1) Operating Voltage: 16.8V
- 2) Frame frequency: 70.0Hz

7.3 Brightness Characteristic

Item	Symbol	Condition	Min.	Typ.	Max.	Unit
Brightness	Bp	Ta=25 ±3	65	-	-	cd/m ²
Uniformity	Bp	30-80%RH	-	-	60	%

Note:

1. The data is measured after LEDs are turned on for 5 minutes.
2. Testing conditions LED: V_{LED} = 10.0 (DC)
 LCD: All dots are on (White color)
3. Brightness in the center of the LCD panel.
4. Definition of Uniformity (Bp)
 $Bp = Bp \text{ (Min.)} / Bp \text{ (Max.)} \times 100 \text{ (\%)}$
 Bp (Max.) = Maximum brightness in 9 measurement spots
 Bp (Min.) = Minimum brightness in 9 measurement spots

8. Reliability

8.1 Content of Reliability Test

Ta=25

No.	Test Item	Content of Test	Test condition
1	High Temperature Storage	Endurance test applying the high storage temperature for a long time	80 ±2 240H Restore 4H at 25
2	Low Temperature Storage	Endurance test applying the low storage temperature for a long time	-30 ±2 240H Restore 4H at 25
3	High Temperature /Humidity Storage	Endurance test applying the high temperature and high humidity storage for a long time	70 ±2 90%RH 240H Restore 4H at 25
4	Temperature Cycle	Endurance test applying the low and high temperature cycle -30 25 80 25 30min 5min 30min 5min 1 cycle	-30 /80 10 cycles Restore 4H at 25
5	Vibration Test (package state)	Endurance test applying the vibration during transportation	10Hz~150Hz, 100m/s ² , 120min
6	Shock Test (package state)	Endurance test applying the shock during transportation	Half- sine wave, 300m/s ² , 18ms
7	Atmospheric Pressure Test	Endurance test applying the atmospheric pressure during transportation by air	25kPa 16H Restore 2H

8.2 Failure Judgment Criterion

Criterion Item	Test Item No.									Failure Judgement Criterion
	1	2	3	4	5	6	7	8	9	
Basic Specification	√	√	√	√	√	√	√	√	√	Out of the basic Specification
Electrical specification	√	√	√	√	√					Out of the electrical specification
Mechanical Specification							√	√		Out of the mechanical specification
Optical Characteristic	√	√	√	√	√	√			√	Out of the optical specification
Note	For test item refer to 8.1									
Remark	Basic specification = Optical specification + Mechanical specification									

9. Quality Level

Examination or Test	At $T_a=25$ (unless otherwise stated)	Inspection				
		Min.	Max.	Unit	IL	AQL
External Visual Inspection	Under normal illumination and eyesight condition, the distance between eyes and LCD is 25cm.	See Appendix A			II	Major 1.0 Minor 2.5
Display Defects	Under normal illumination and eyesight condition, display on inspection.	See Appendix B			II	Major 1.0 Minor 2.5
Note: Major defects: Open segment or common, Short, Serious damages, Leakage Miner defects: Others Sampling standard conforms to GB2828						

10. Precautions for Use of LCD Modules

10.1 Handling Precautions

10.1.1 The display panel is made of glass. Do not subject it to a mechanical shock by dropping it from a high place, etc.

10.1.2 If the display panel is damaged and the liquid crystal substance inside it leaks out, be sure not to get any in your mouth, if the substance comes into contact with your skin or clothes, promptly wash it off using soap and water.

10.1.3 Do not apply excessive force to the display surface or the adjoining areas since this may cause the color tone to vary.

10.1.4 The polarizer covering the display surface of the LCD module is soft and easily scratched. Handle this polarizer carefully.

10.1.5 If the display surface is contaminated, breathe on the surface and gently wipe it with a soft dry cloth. If still not completely clear, moisten cloth with one of the following solvents:

- Isopropyl alcohol
- Ethyl alcohol

Solvents other than those mentioned above may damage the polarizer. Especially, do not use the following:

- Water
- Ketone
- Aromatic solvents

10.1.6 Do not attempt to disassemble the LCD Module.

10.1.7 If the logic circuit power is off, do not apply the input signals.

10.1.8 To prevent destruction of the elements by static electricity, be careful to maintain an optimum work environment.

- a. Be sure to ground the body when handling the LCD Modules.
- b. Tools required for assembly, such as soldering irons, must be properly ground.
- c. To reduce the amount of static electricity generated, do not conduct assembly and other work under dry conditions.
- d. The LCD Module is coated with a film to protect the display surface. Be care when peeling off this protective film since static electricity may be generated.

10.2 Storage precautions

10.2.1 When storing the LCD modules, avoid exposure to direct sunlight or to the light of fluorescent lamps.

10.2.2 The LCD modules should be stored under the storage temperature range. If the LCD modules will be stored for a long time, the recommend condition is:

Temperature : 0 ~ 40



Relatively humidity: 80%

10.2.3 The LCD modules should be stored in the room without acid, alkali and harmful gas.

10.3 The LCD modules should be no falling and violent shocking during transportation, and also should avoid excessive press, water, damp and sunshine.

Appendix A

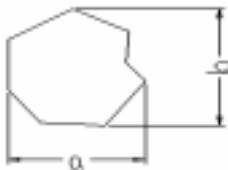
Inspection items and criteria for appearance defects

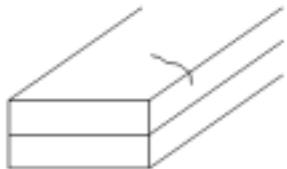
Items	Contents	Criteria		
Leakage		Not permitted		
Rainbow		According to the limit specimen		
Polarizer	Wrong polarizer attachment	Not permitted		
	Bubble between polarizer and glass	Not counted	Max. 3 defects allowed	
		$\phi < 0.3\text{mm}$	0.3mm ϕ 0.5mm	
	Scratches of polarizer	According to the limit specimen		
Black spot (in viewing area)		Not counted	Max. 3 spots allowed	Max. 3 spots (lines) allowed
		$X < 0.2\text{mm}$	0.2mm X 0.5mm	
		$X = (a+b)/2$		
Black line (in viewing area)		Not counted	Max. 3 lines allowed	
		$a < 0.02\text{mm}$	0.02mm a 0.05mm b 2.0mm	
Progressive cracks		Not permitted		

Appendix A

Inspection item and criteria for appearance defects (continued)

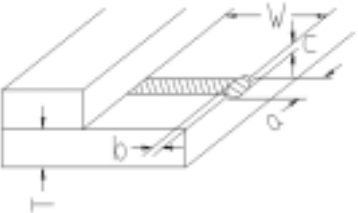
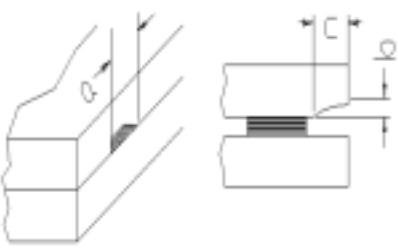
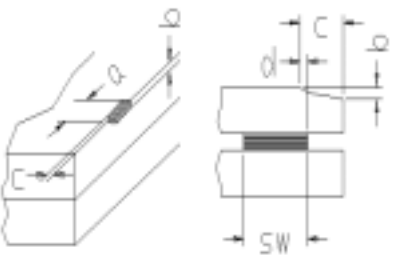
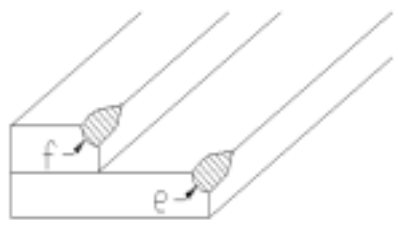
Items	Contents	Criteria				
Glass Cracks	Cracks on pads 	a	b	c	Max. 2 cracks allowed	Max. 5 cracks allowed
	3mm	W/5	T/2			
	2mm	W/5	$T/2 < C < T$			
	Cracks on contact side 	a	b		Max. 2 cracks allowed	
	3mm	T/2				
	2mm	$T/2 < b < T$				
	C shall be not reach the seal area					
	Cracks on non-contact side 	a	b		Max. 2 cracks allowed	
	3mm	T/2				
	2mm	$T/2 < b < T$				
C 0.5mm						
d SW/3						
Corner cracks 	$e < 2.0\text{mm}^2$ $f < 2.0\text{mm}^2$			Max. 3 cracks allowed		

Appendix B

Inspection items and criteria for display defects

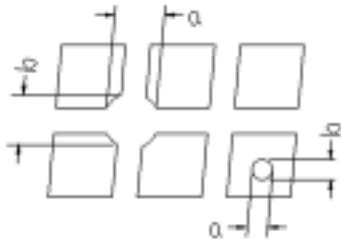
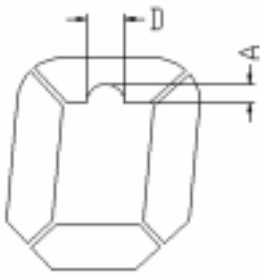
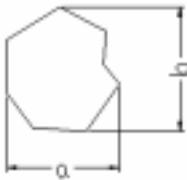
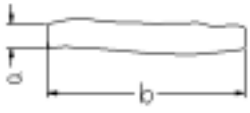
Items	Contents	Criteria			
Open segment or open common		Not permitted			
Short		Not permitted			
Wrong viewing angle		Not permitted			
Contrast ratio uneven		According to the limit specimen			
Crosstalk		According to the limit specimen			
Pin holes and cracks in segment (DOT)		Not counted	Max.3 dots allowed		Max.3 dots allowed
		$X < 0.1\text{mm}$	0.1mm X 0.2mm		
		$X = (a+b)/2$			
		Not counted	Max.2 dots allowed		
$A < 0.1\text{mm}$		0.1mm A 0.2mm $D < 0.25\text{mm}$			
Black spot (in viewing area)		Not counted	Max.3 spots allowed		Max.3 spots (lines) allowed
		$X < 0.1\text{mm}$	0.1mm X 0.2mm		
		$X = (a+b)/2$			
Black line (in viewing area)		Not counted	Max.3 lines allowed		
		$a < 0.02\text{mm}$	0.02mm a 0.05mm b 0.5mm		

Appendix B

Inspection items and criteria for display defects (continued)

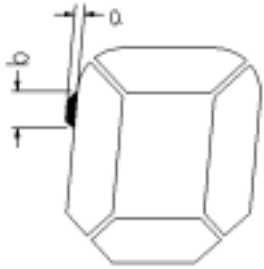
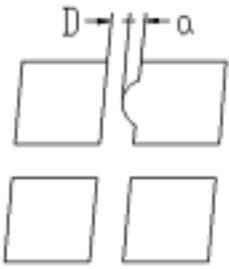
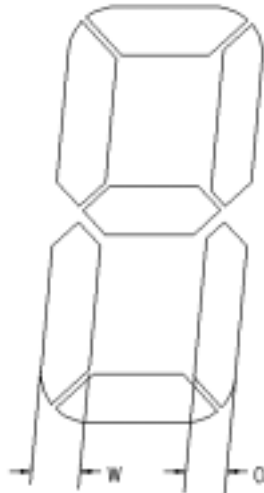
Items	Content	Criteria			
Transformation of segment		Not counted	Max. 2 defects allowed	Max.3 defects allowed	
	$x < 0.1\text{mm}$		0.1mm x 0.2mm		
	$x = (a+b)/2$				
		Not counted	Max. 1 defects allowed		
	$a < 0.1\text{mm}$		0.1mm a 0.2mm $D > 0$		
		Max.2 defects allowed $0.8W \leq a \leq 1.2W$ $a = \text{measured value of width}$ $W = \text{nominal value of width}$			