

SPECIFICATION FOR LCD MODULE

Model No. TM9664FKIWG-1

Prepared by:	Date:
Checked by :	Date:
Verified by :	Date:
Approved by:	Date:

TIANMA MICROELECTRONICS CO., LTD

Ver.1.0

REVISION RECORD

Date	Rev.No.	Revision Items	Prepared	Checked	Approved

CONTENTS

	Page
1. General Specifications -----	4
2. Outline Drawing -----	5
3. Circuit Block Diagram -----	6
4. Absolute Maximum Ratings -----	7
5. Electrical Specifications and Instruction Code -----	8
6. Optical Characteristics -----	13
7. Reliability -----	17
8. Quality level-----	18
9. Precautions for Use of LCD Modules -----	22

1.General Specifications

Item	Contents	Unit	Note
LCD Type	Color STN	-	
Display color	4K		1
LCD Duty	1/64	-	
LCD Bias	1/8	-	
Viewing Direction	6:00	O'Clock	
Viewing Area(W×H)	22.96×16.48	mm	
Active Area(W×H)	20.15×13.43	mm	
Number of Dots	96(RGB)×64	mm	
Dote Size(W×H)	0.195×0.195	mm	
Dot Pitch(W×H)	0.210×0.210	mm	
Controller	SSD1788	-	
V _{DD}	3.0	V	
V _{op}	12.0	V	
Outline Dimensions	Refer to outline drawing on next page		
Backlight	-	-	
Operating Temperature	-20 ~ +70	-	
Storage Temperature	-30 ~ +80	-	
Weight	TBD	g	2
Data Transfer	8 bits parallel	-	
Polarizer Mode	Transflective/Negative	-	

Note

1:

Color tune is slightly changed by temperature and driving voltage.

Note 2: TBD- To Be Determined.

2. Outline Drawing

NO.	SYMBOL
1	PS0
2	PS1
3	CS
4	RES
5	D/C
6	R/W
7	E
8	DB0
9	DB1
10	DB2
11	DB3
12	DB4
13	DB5
14	DB6
15	DB7
16	CS
17	VDD_ID
18	VCI
19	RVSS
20	CVSS
21	VSS
22	VL2
23	VL3
24	VL4
25	VL5
26	V/DUT

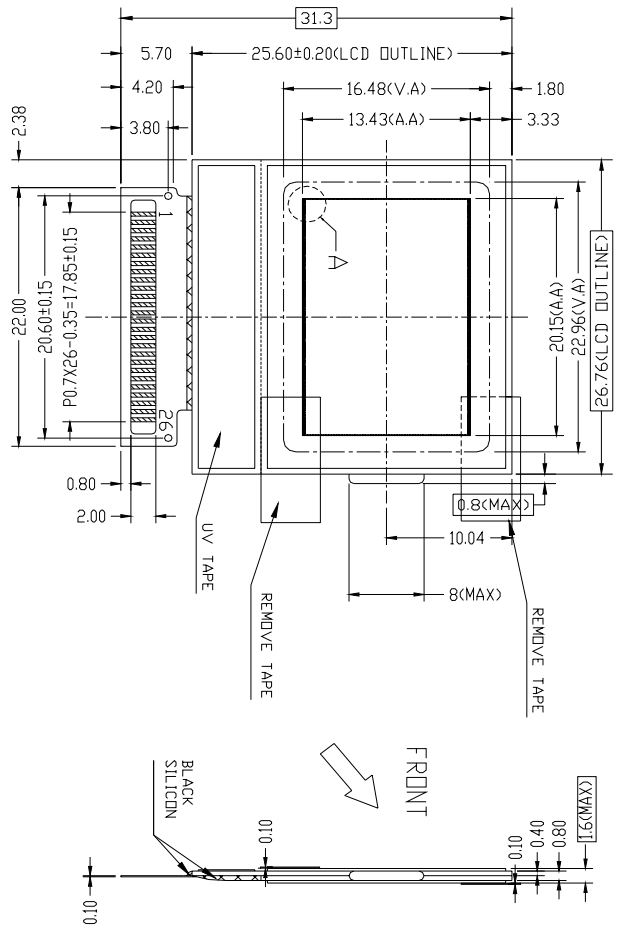

NOTES:
 1.DISPLAY TYPE: CSTN
 2.VIEWING DIRECTION: 6:00
 3.DRIVE IC: SSD1788
 4.POLARIZER MODE: TRANSPARENT/NEGATIVE
 5.DRIVE METHOD: 1/64 DUTY 1/8 BIAS
 6.VDD: 3V
 7.VLCD: 12.0V
 8.OPERATING TEMP: -20°C -- 70°C
 9.STORAGE TEMP: -30°C -- 80°C
 10.UNMARKED TOLERANCE: ±0.30

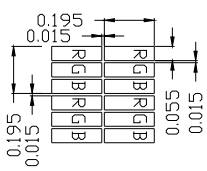

<p>TIAN-MA MICROELECTRONICS CO.</p> <p>22/F., CASTIC Building, Shekou Road, Central, Shenzhen, China</p>	
DRAWN BY:	TITLE: TM9664FKIWG-1
CHECKED BY:	DWG NO.: G-3
APPROVED BY:	SCALE:
CONFIRMED BY:	UNIT: mm
	DWG NAME: TM9664FKIWG-1 G-3 SHEET NO.: 1 OF 1

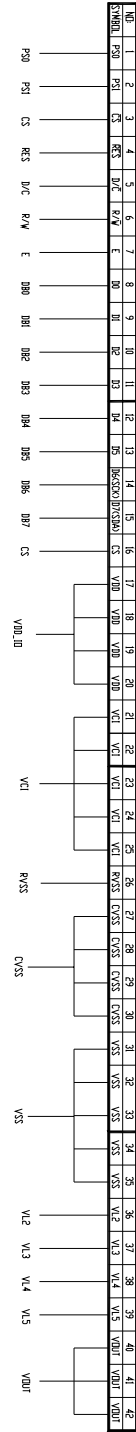

3. Circuit Block Diagram

I/O1:



I/O2:

NO.	1	2	3	4	5	6	7	8	9	10	11	12	13	14	15	16	17	18	19	20	21	22	23	24	25	26
SYMBOL	PS0	PS1	CS	RES	D/C	R/W	E	DB0	DB1	DB2	DB3	DB4	DB5	DB6	DB7	CS	VDD1	VCI	RVSS	CVSS	VSS	V1.2	V1.3	V1.4	V1.5	VOUT

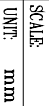
 <p>TIAN-MA MICROELECTRONICS CO. 22/F., HANGJIA Building, Shennan Road, Central, Shenzhen, China</p>		DRAWN BY:	
		CHECKED BY:	
APPROVED BY:	DWG NO.: DCC(FPC)-1	SCALE:	
	DWG NAME: TM9664FKIWG-1	UNIT: mm	
		SHEET NO.: 1 OF 1	

4. Absolute Maximum Ratings($T_a=25$)

Item	Symbol	Min.	Max.	Unit	Note
Power Supply Voltage(1)	V_{BAT}	3.2	4.5	V	1,2
Power Supply Voltage(2)	V_{DD}	-0.3	3.3	V	
Power Supply Voltage for LCD	V_{op}	11.7	12.3	V	
Logic Signal Input Voltage	V_I	-0.3	$V_{DD}+0.3$	V	
Operating Temperature	T_{op}	-20	+70		
Storage Temperature	T_{st}	-30	+80		

Notes:

1. If the module is above these absolute maximum ratings. It may become permanently damaged. Using the module within the following electrical characteristic conditions are also exceeded, the module will malfunction and cause poor reliability.
2. $V_{DD} > V_{SS}$ must be maintained.

5. Electrical Specifications and Instruction Code

5.1 Electrical characteristics (Ta=25)

Parameter	Symbol	Condition	Min	Typ	Max	Unit	Note	
Supply voltage	V _{BAT}	Ta=25	3.2	3.8	4.5	V		
Operation voltage	V _{OP}	Ta=25	11.7	12.0	12.3	V	1	
Input voltage	‘H’	V _{IH}	V _{DD} =3.0V	0.8V _{DD}	-	V _{DD}	V	
	‘L’	V _{IL}	V _{DD} =3.0V	V _{SS}	-	0.2V _D D	V	
Output Voltage	‘H’	V _{OH}	-	0.8V _{DD}	-	V _{DD}	V	
	‘L’	V _{OL}	-	V _{SS}	-	0.2V _D D	V	
Current Consumption	I _{CC1}	Normal mode	-	2	3.5	mA	2	
	I _{CC2}	Stand-by mode	-	-	-	mA	3	

Note:

1: IC default setting, Duty:1/64,Bias:1/8.

2: Display full white.

3: IC on standby mode.

5.2 Interface Signals

Pin No.	Symbol	I/O	Function
1	PS0	I	bus interface mode selection input
2	PS1	I	bus interface mode selection input
3	CS	I	chip selection input
4	RES	I/O	reset signal input
5	D/C	I	Data/Command control pin
6	R/W	I	Write control signal input
7	E	I	Read control signal input
8	DB0	I/O	8bits data bus
9	DB1	I/O	
10	DB2	I/O	
11	DB3	I/O	
12	DB4	I/O	
13	DB5	I/O	
14	DB6	I/O	
15	DB7	I/O	
16	CS	I/O	LCD Chip select input pin
17	VDD IO	I	Power supply for LCM
18	VCI	I	Reference voltage input pin
19	RVSS	I	ground of Vref
20	CVSS	I/O	ground of analog
21	VSS	I/O	ground of logic
22	VL2	I/O	LCD driving voltages
23	VL3	I/O	
24	VL4	I/O	
25	VL5	I/O	
26	VOUT	I/O	

5.3 Interface Timing Chart(SSD1788 INTERFACE PROTOCOL)

Table 16 – Parallel 8080-series Interface Timing Characteristics
 (T_A = -40 to 85°C, V_{DD} = 2.6V to 3.6V, V_{DDIO} = 1.2V to V_{DD})

Symbol	Parameter	Min	Typ	Max	Unit
t _{CC}	Clock Cycle Time (write cycle)	130	-	-	ns
PW _{CSL}	Control Pulse Low Width	65	-	-	ns
PW _{CSH}	Control Pulse High Width	65	-	-	ns
t _{AS}	Address Setup Time	15	-	-	ns
t _{AH}	Address Hold Time	10	-	-	ns
t _{DS}	Data Setup Time	10	-	-	ns
t _{DH}	Data Hold Time	20	-	-	ns
t _{ACC}	Data Access Time	15	-	170	ns
t _{OH}	Output Hold time	20	-	60	ns

Write Cycle

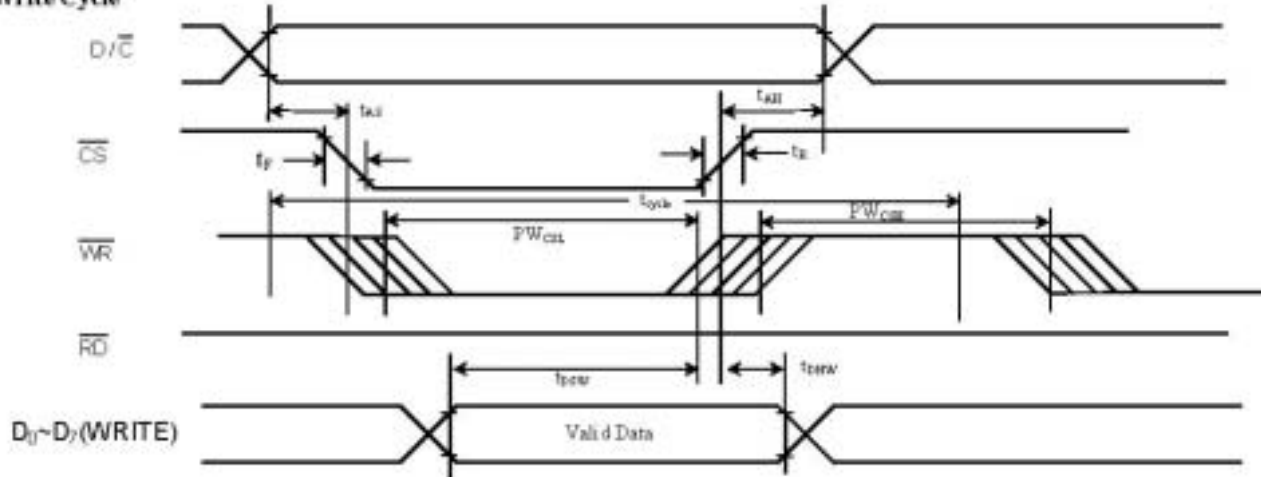

Read Cycle

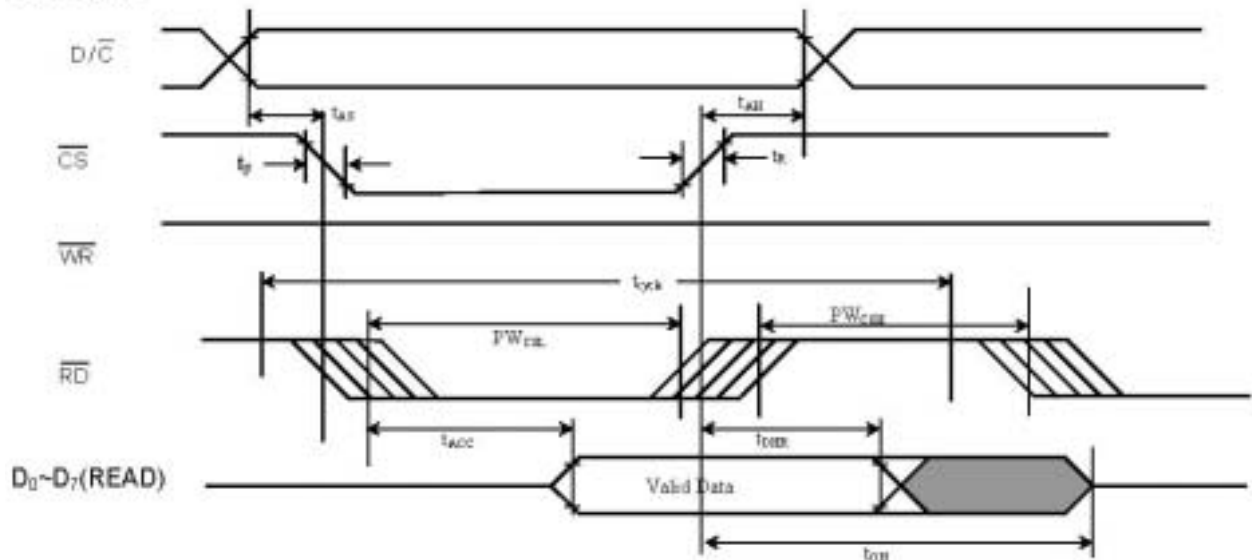

Figure 20 – Parallel 8080-series Interface Timing Characteristics (PS0 = H, PS1 = L)

5.5 COMMAND TABLE

Command Table (D/ $\bar{C} = 0, R/\bar{W} (\bar{WR}) = 0, E=1(\bar{RD} = 1)$ unless specific setting is stated)

D/C	Hex	D7	D6	D5	D4	D3	D2	D1	D0	Command	Description
0 1 1	15	0 X_7 Y_7	0 X_6 Y_6	0 X_5 Y_5	1 X_4 Y_4	0 X_3 Y_3	1 X_2 Y_2	0 X_1 Y_1	1 X_0 Y_0	Set Column Address	Set the start column address by $X_7X_6X_5X_4X_3X_2X_1X_0$ Set the end column address by $Y_7Y_6Y_5Y_4Y_3Y_2Y_1Y_0$ Column address = 00000000b (POR) In 8-levels gray scale mode, column address is in a range of 0~97. In 16-level gray scale mode, column address is in a range of 0~48.
0 1 1	75	0 X_7 Y_7	1 X_6 Y_6	1 X_5 Y_5	1 X_4 Y_4	0 X_3 Y_3	1 X_2 Y_2	0 X_1 Y_1	1 X_0 Y_0	Set Row Address	Set the start page address by $X_7X_6X_5X_4X_3X_2X_1X_0$ Set the end page address by $Y_7Y_6Y_5Y_4Y_3Y_2Y_1Y_0$ Page address = 00000000b (POR)
0 1	BB	1 *	0 *	1 *	1 *	1 *	0 X_2	1 X_1	1 X_0	Set COM Output Scan Direction	$X_2 X_1 X_0$ ROW0...ROW33 ROW34...ROW67 0 0 0 COM0->COM33 COM34->COM67 (POR) 0 0 1 COM0->COM33 COM67-<COM34 0 1 0 COM33-<COM0 COM34->COM67 0 1 1 COM33-<COM0 COM67-<COM34
0 1 1 1	BC	1 * * *	0 * * *	1 * * *	1 * * *	1 * * *	1 P_{12} P_{22} P_{32}	0 P_{11} P_{21} P_{31}	0 P_{10} P_{20} P_{30}	Set COM Output Scan Direction	a) Normal or Reverse page/column/scan directions $P_{10} = 0$: set page address to normal display (POR) $P_{10} = 1$: set page address to inverse display $P_{11} = 0$: set column address to normal rotation (POR) $P_{11} = 1$: set column address to inverse rotation $P_{12} = 0$: set scan direction to column scan (POR) $P_{12} = 1$: set scan direction to page scan Please refer to the Figure 7 & Figure 8 on page 35 & 36 respectively for detail description of column/page scan direction modes b) RGB color arrangement P_{22}, P_{21}, P_{20} : The control bits are used for setting the (RGB) color arrangement of segment output. . 000 is the POR value. Please refer to the Figure 10 on page 37 for detail mapping of the segment output. c) Gray-scale selection $P_{32} P_{31} P_{30}$ Gray-scale modes 0 0 1 8-levels gray scale mode (POR) 0 1 0 16-levels gray scale mode (Type A) Please refer to the Table 9 on page 37 to Table 10 on page 37 for detail description of different gray-scale selection modes.

6 Optical Characteristics

Item	Symbol	Condition	Min.	Typ.	Max.	Unit	Note
Brightness	Bp	$\Phi_1=0^\circ$	-			Cd/m ²	1
Uniformity	Bp	$\Phi_2=0^\circ$	70%				1,2
Viewing Angle	Φ_1 (up down)	$Cr \geq 2$	-40 ~ +35			Deg	3
	Φ_2 (left right)		-30 ~ +30				
Contrast Ratio	Cr	$\Phi_1=0^\circ$ $\Phi_2=0^\circ$	30	40	60	-	4
Response Time	Tr		-	-	180	ms	5
	Tf	70	-	90			
Color of CIE Coordinate	W	x	-	0.30	-	-	1,6
		y	-	0.36	-	-	
	R	x	-	0.53	-	-	
		y	-	0.37	-	-	
	G	x	-	0.31	-	-	
		y	-	0.51	-	-	
	B	x	-	0.16	-	-	
		y	-	0.18	-	-	
NTSC Ratio	S		25%				

Note 1: The data are measured after LEDs are turned on for 5 minutes. LCM displays full white. The brightness is the average value of 9 measured spots. Measurement equipment PR-705 (Φ10mm)

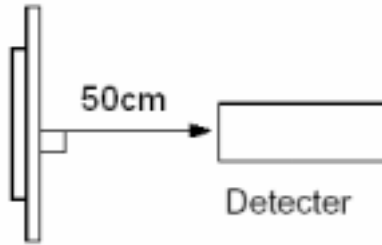

Note 2: $B_p = B_p (\text{Min.}) / B_p (\text{Max.}) \times 100 (\%)$

$B_p (\text{Max.})$ = Maximum brightness in 9 measured spots

$B_p (\text{Min.})$ = Minimum brightness in 9 measured spots.

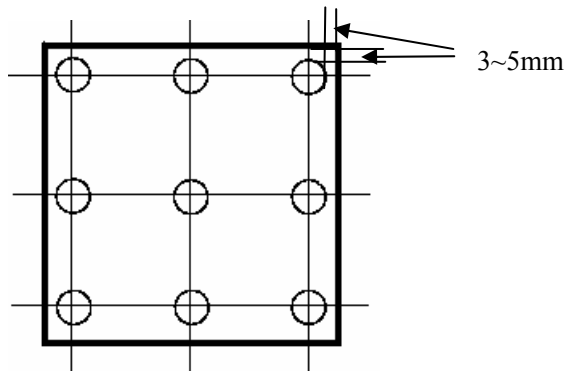

Measurement equipment PR-705 (Φ10mm)

Note 3: Definition of Viewing Angle(Test LCD using DMS501)

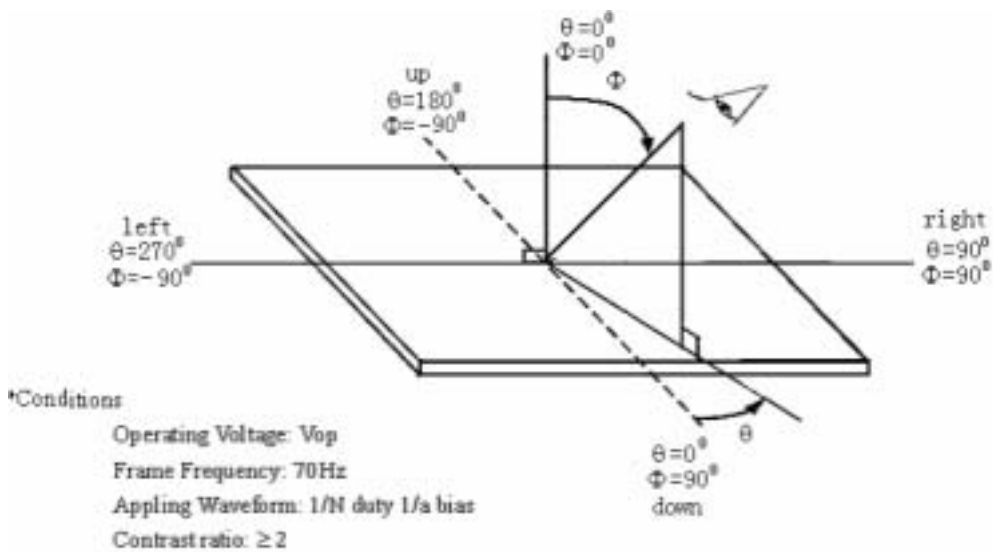

Note 4: Definition of contrast ratio.(Test LCD using DMS501)

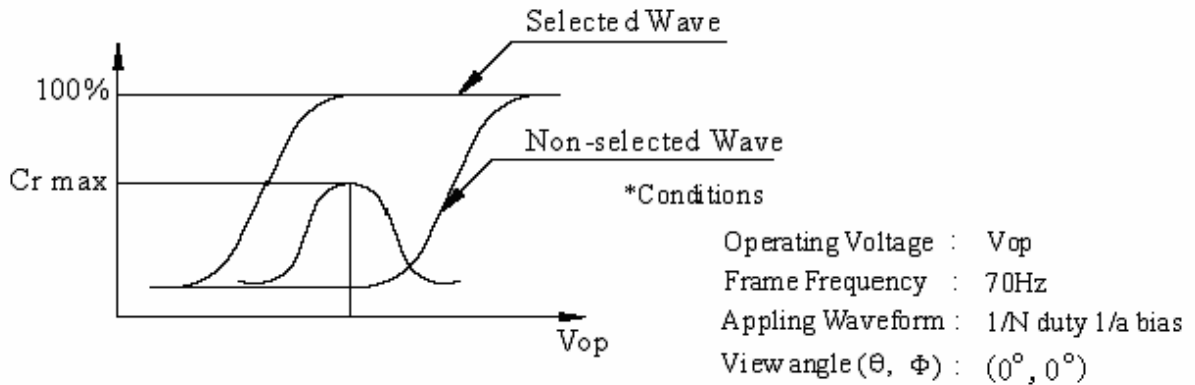

$$\text{Contrast ratio}(Cr) = \frac{\text{Brightness of selected dots}}{\text{Brightness of non-selected dots}}$$

Note 5: Definition of Response time(Test LCD using DMS501)

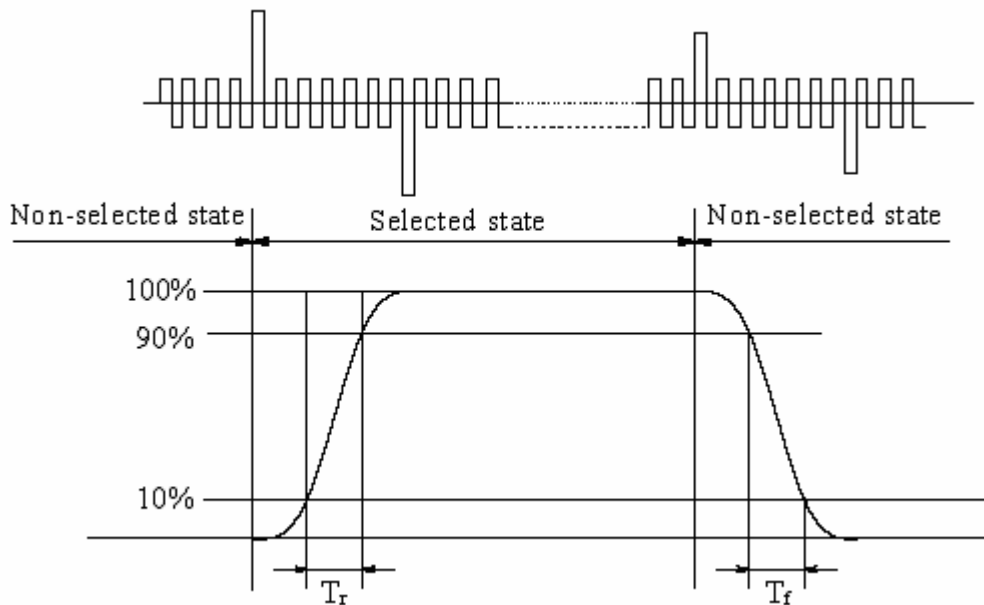

Operating Voltage: V_{op}

Frame Frequency: 70Hz

Applying Waveform: 1/N duty 1/a bias

View angle (θ, Φ): ($0^\circ, 0^\circ$)

Note 6: Definition of Color of CIE Coordinate and NTSC Ratio.

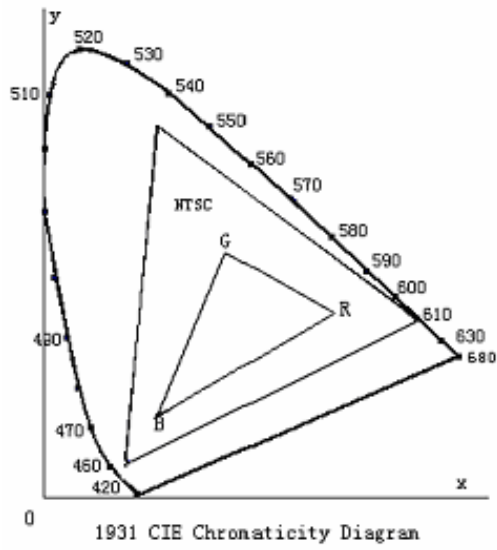

Color gamut:

$$S = \frac{\text{area of } RGB \text{ triangle}}{\text{area of } NTSC \text{ triangle}} \times 100\%$$

7. Reliability

No.	Test Item	Test condition	Criterion
1	High Temperature Storage	80 ±2 96H Restore 4H at 25	1. After testing, cosmetic defects should not happen. 2.Total current consumption should not be over 10% of initial value.
2	Low Temperature Storage	-30 ±2 96H Restore 4H at 25	
3	High Temperature Operation	70 ±2 48H Restore 4H at 25	
4	Low Temperature Operation	-20 ±2 48H Restore 4H at 25	
5	High Temperature /Humidity Storage	40 ±2 90%RH 48H	
6	Temperature Cycle	-30 ↔25 ↔80 5min 30min ↔25 , 5min after 10cycle, Restore 4H at 25	
7	Vibration Test (package state)	10Hz~150Hz, 100m/s ² , 120min	Not allowed cosmetic and electrical defects.
8	Shock Test (package state)	Half- sine wave, 300m/s ² , 18ms	
9	Atmospheric Pressure Test	25kPa 16H Restore 2H	
10	Cable Bending Test	Bending area and angle follow design document requirement	More than 50000 times

8 Quality level

8.1 Notes for quality standard

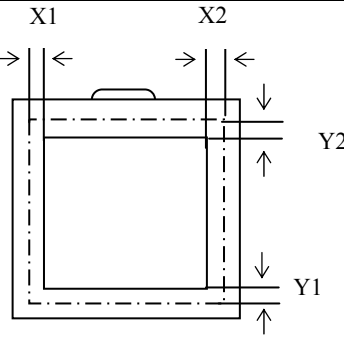
	Note	
General	1. Should any defects which are not specified in this standard happen, additional standard shall be determined by mutual agreement between customer and Tianma. 2. Viewing Area should be the area which Tianma guarantees. 3. Limited sample should be prior to this Inspection standard. 4. Viewing Judgement should be under static pattern. 5. Inspection conditions Inspection distance : 250 mm (from the sample) Temperature : 25±5 Inspection angle : 45degrees in LCD view direction	
Definitions of Inspection items	Pinhole, Bright spot, Black spot, White spot, Black line, White Line, Foreign particle, Bubble	The color of a small area is different from the remainder. The phenomenon dose not change with voltage.
	Contrast variation	The color of a small area is different from the remainder. The phenomenon changes with voltage.
	Polarizer defect	Scratch, Dirt, Particle, Bubble on polarizer or between polarizer and glass.
	Glass defect	Glass crack, Shaved corner of glass, Surplus glass
Definitions of Inspection ranges	 <p style="text-align: center;">Dividing A zone and B zone proceed to make a judgment.</p> <p>A zone : Inside Viewing area B zone : Outside Viewing area X1(A.A~V.A): mm X2(A.A~V.A): mm Y1(A.A~V.A): mm Y2(A.A~V.A): mm</p>	
Outgoing Inspection standard	Inspection level Normal Inspection Sampling standard conforms to GB2828	
	Rank	Inspection Item
		AQL(Number of defective LCMs counted)
Major defect	All Functional defects(Such as No display, Display abnormally, Open or missing segment, Short circuit , Missing component, No sound, Blight abnormally),Outline dimension beyond the drawing	0.65
Minor defect	Appearance defects, such as Black/White spot, Bright spot, Pinhole, Black/White line, Contrast variation, Bubble Glass defect, Polarizer defect, and so on. Details of the standard as follows.	1.50

8.2 Standards of inspection items

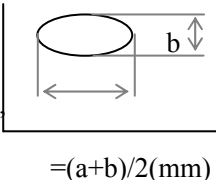
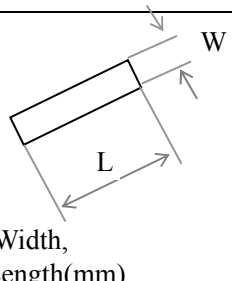
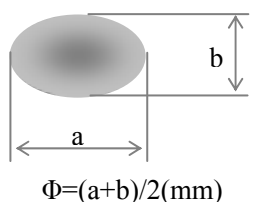
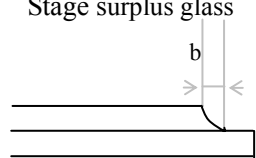
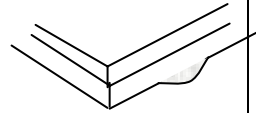
Inspection item		Judgement standard					
		Category		Acceptable number			
				A zone	B zone		
1	Black spot, White spot Bright Spot, Pinhole Foreign Particle, Bubble and Particle Between polarizer and glass, Scratch on polarizer		A	0.15	Neglecte	Neglected	
			B	0.15 < 0.20	2		
			C	0.20 < 0.30	1		
			D	0.30 <	0		
		Total defective point(B,C)		3			
2	Black line, White line, Bubble and Particle Between Polarizer and glass, Scratch on polarizer		A	W 0.10	Neglected	Neglected	
			B	0.01 < W 0.03 L 3.0	2		
			C	0.03 < W 0.05 L 3.0	1		
			D	0.05 < W	0		
					Total defective point(B,C)		2
3	Contrast variation		A	Φ 0.2	Neglected	Neglected	
			B	0.2 < Φ 0.3	2		
			C	0.3 < Φ 0.4	1		
			D	0.4 < Φ	0		
					Total defective point(B,C)		3
4	Bubble inside cell		any size	none	none		
5	Polarizer defect (if Polarizer is used)	Scratch and damage on polarizer, Particle on polarizer or between polarizer and glass.	Refer to item 1 and item 2.				
			Bubble, dent and convex	A	Φ 0.3	Neglected	Neglected
				B	0.3 < Φ 0.7	2	
				C	0.7 < Φ	0	
		Total defective point(B,C)		2			
6	Surplus glass	Stage surplus glass					
		Surrounding surplus glass					
		Should not influence outline dimension and assembling.					

Inspection item		Judgment standard									
		Category(application: B zone)									
7	Glass defect crack	The front of lead terminals	<table border="1"> <tr> <td>A</td> <td>If $a \leq t$ and $b \leq 1.0$, c is not limited</td> </tr> <tr> <td>B</td> <td>$a \leq t$, $1 \leq b \leq 2\text{mm}$, $c \leq 3\text{mm}$</td> </tr> <tr> <td>C</td> <td>If glass crack cover alignment mark, $b \leq 0.5\text{mm}$.</td> </tr> <tr> <td>D</td> <td>Crack at two sides of lead terminals should not cover patterns and alignment mark</td> </tr> </table>	A	If $a \leq t$ and $b \leq 1.0$, c is not limited	B	$a \leq t$, $1 \leq b \leq 2\text{mm}$, $c \leq 3\text{mm}$	C	If glass crack cover alignment mark, $b \leq 0.5\text{mm}$.	D	Crack at two sides of lead terminals should not cover patterns and alignment mark
		A	If $a \leq t$ and $b \leq 1.0$, c is not limited								
		B	$a \leq t$, $1 \leq b \leq 2\text{mm}$, $c \leq 3\text{mm}$								
		C	If glass crack cover alignment mark, $b \leq 0.5\text{mm}$.								
D	Crack at two sides of lead terminals should not cover patterns and alignment mark										
Surrounding crack—non-contact side seal	$b <$ Inner borderline of the seal										
Surrounding crack— contact side	$b <$ Outer borderline of the seal										
Corner	<table border="1"> <tr> <td>A</td> <td>$a \leq t$, $b \leq 3.0$, $c \leq 3.0$</td> </tr> </table> <p>*Glass crack should not cover patterns used for</p>	A	$a \leq t$, $b \leq 3.0$, $c \leq 3.0$								
A	$a \leq t$, $b \leq 3.0$, $c \leq 3.0$										

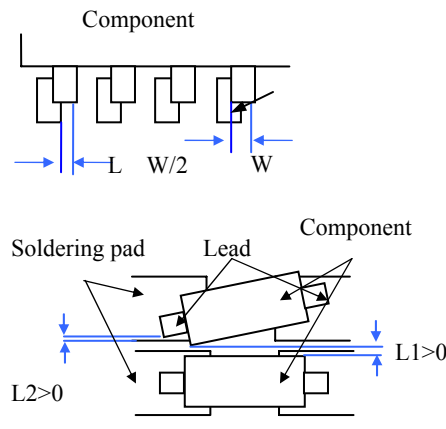
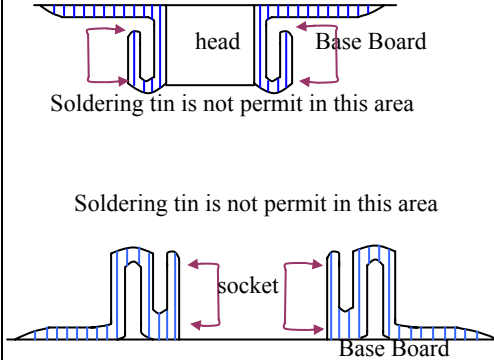
Inspection item		Judgement standard	
8	PCB defect	<p>Component soldering: No cold soldering, short, open circuit, burr, tin ball The flat encapsulation component position deviation must be less than 1/2 width of the pin (Pic.1) ; the sheet component deviation: Pin deviates from the pad and contact with the near components is not permitted (Pic.2)</p>	
		<p>lead defect: The lead lack must be less than 1/2 of its width; The lead burr must be less than 1/2 of the seam; Impurities connect with the near leads is not permitted</p>	
		<p>Connector soldering: Soldering tin is at contact position of the plug and socket is not permitted No foundation is scald Serious cave distortion on plug and socket contact pin is not permitted</p>	

9. Precautions for Use of LCD Modules

9.1 Handling Precautions

9.1.1 The display panel is made of glass. Do not subject it to a mechanical shock by dropping it from a high place, etc.

9.1.2 If the display panel is damaged and the liquid crystal substance inside it leaks out, be sure not to get any in your mouth, if the substance comes into contact with your skin or clothes, promptly wash it off using soap and water.

9.1.3 Do not apply excessive force to the display surface or the adjoining areas since this may cause the color tone to vary.

9.1.4 The polarizer covering the display surface of the LCD module is soft and easily scratched. Handle this polarizer carefully.

9.1.5 If the display surface is contaminated, breathe on the surface and gently wipe it with a soft dry cloth. If still not completely clear, moisten cloth with one of the following solvents:

- Isopropyl alcohol

- Ethyl alcohol

Solvents other than those mentioned above may damage the polarizer. Especially, do not use the following:

- Water

- Ketone

- Aromatic solvents

9.1.6 Do not attempt to disassemble the LCD Module.

9.1.7 If the logic circuit power is off, do not apply the input signals.

9.1.8 To prevent destruction of the elements by static electricity, be careful to maintain an optimum work environment.

- a. Be sure to ground the body when handling the LCD Modules.

- b. Tools required for assembly, such as soldering irons, must be properly ground.

- c. To reduce the amount of static electricity generated, do not conduct assembly and other work under dry conditions.

-
- d. The LCD Module is coated with a film to protect the display surface. Be care when peeling off this protective film since static electricity may be generated.

9.2 Storage precautions

9.2.1 When storing the LCD modules, avoid exposure to direct sunlight or to the light of fluorescent lamps.

9.2.2 The LCD modules should be stored under the storage temperature range. If the LCD modules will be stored for a long time, the recommend condition is:

Temperature : 0 ~ 40

Relatively humidity: ≤80%

9.2.3 The LCD modules should be stored in the room without acid, alkali and harmful gas.

9.3 The LCD modules should be no falling and violent shocking during transportation, and also should avoid excessive press, water, damp and sunshine.